



BODYTONICFORM

PRODUCT CATALOGUE



INDIGOFITNESS

info@bodytonicform.com

www.bodytonicform.com



YOUR DREAM

Create the training space of your dreams with the help of our expert team. From design to installation.



GYM DESIGN

Using our experience and skills, along with a little help from the latest in design software, we'll help bring your vision to life.

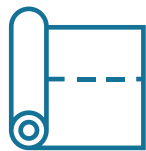

FLOORING

Work with us and you'll benefit from our expertise and technical know-how, gained from years of creating and installing fitness flooring solutions.



EQUIPMENT

We have designed and manufactured strength equipment in the UK for over 25 years.



PERSONALISATION

We can personalise your flooring and equipment. It's your product, your design, your size, your logo, your colour, have it your way!



OUR EXPERIENCE

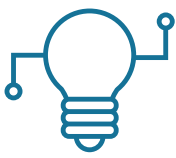

TECHNOLOGY

By deploying the very best in light, sound, and visual technologies we can create a fully immersive training experience.



EDUCATION

We have a range of equipment and instructor training courses and workshops available.



INSTALLATION

Your training space will be finished to a high standard by our friendly and professional install teams, who are fully trained and qualified for site work.



SUPPORT

Our partnership isn't over once the install is complete, we're there for you and your products with on-going support and maintenance.

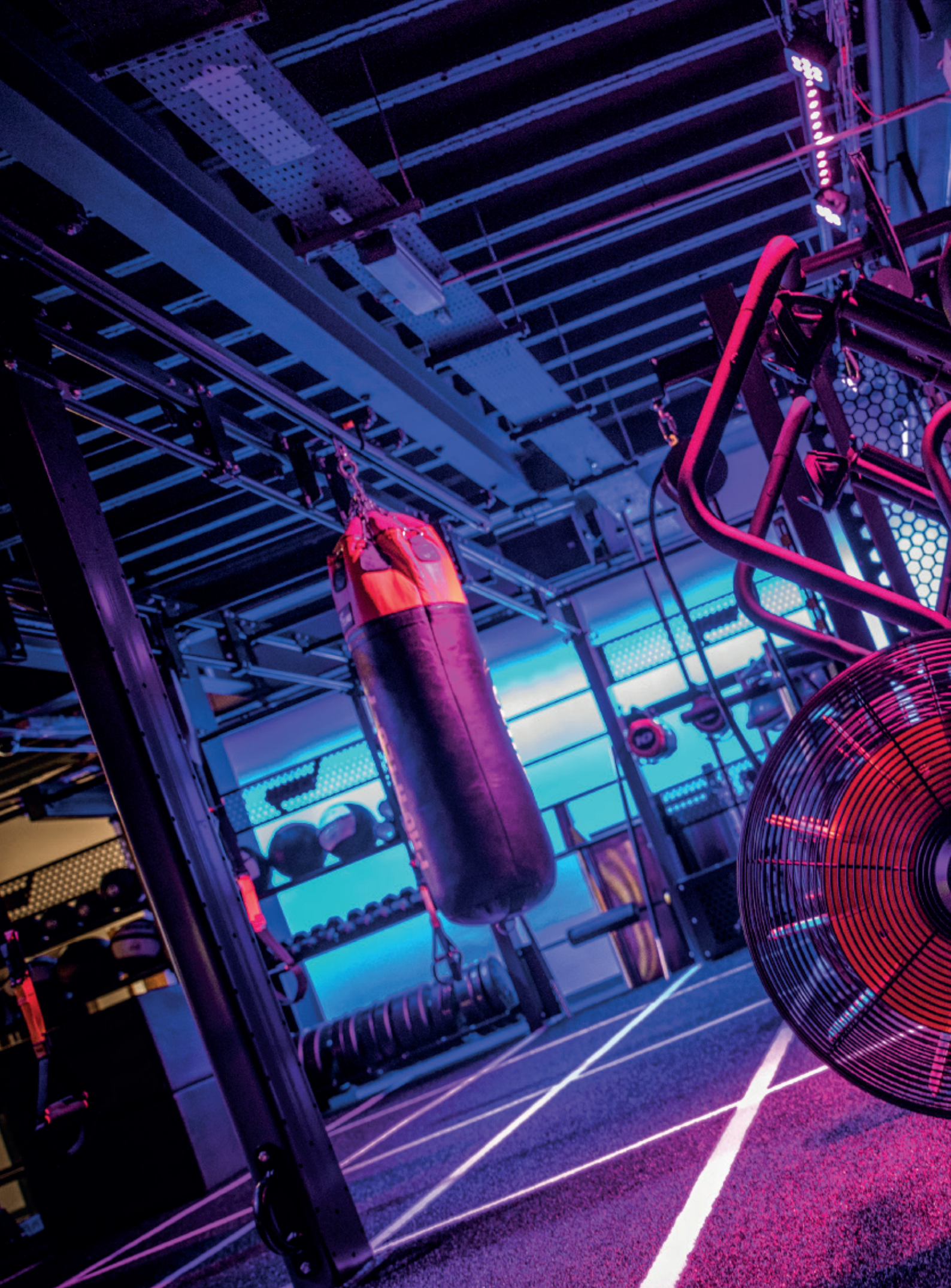

CONTENTS

ABOUT INDIGO FITNESS	7
INTRODUCTION TO RAZE	12
RACKS	14
RIGS	20
STORAGE	26
STRENGTH AND CONDITIONING	34
CARDIO	45
CARBON CLAW	48
STRENGTH STATION	50
OUTDOOR TRAINING	64
KENGURU PRO	66
UPTIVO	68
FLOORING	70
SUPPORT	79





WE ARE INDIGO FITNESS

Founded in 1996, we set out with the simple goal of designing and manufacturing strong and durable strength training equipment and over the years we've developed, evolved, and grown into a full-service solution provider, or as we like to say 'We Create Training Spaces'

We've gained invaluable experience over years of working with hundreds of gyms of all shapes and sizes, in a range of different industries. We understand there is no 'one size fits all' approach and that no two projects are ever the same - that's why we tailor our approach for every client.

The combination of services we offer, covering: gym design, flooring, equipment, training, and after service, allows us to create the best possible training environments for our clients, which in turn allows them to offer the best possible experiences for their members.

This catalogue concentrates on our product ranges.

If you would like to know more about our solutions, please contact us on:

Email: info@bodytonicform.com

FACTORY AND SHOWROOM

We are based in a 20,000sq. ft facility in Nuneaton, Warwickshire. This houses our factory, assembly department, warehousing, showroom and offices.

The showroom is fitted out as a fully working gym environment and shows off a wide range of the equipment we design and manufacture. You are welcome at our HQ any time, we'd be happy to take you on a tour of our factory and the rest of our facility.

ACCREDITATIONS

We use a wide range of standards to improve our performance, reduce risk, work more sustainably, or simply to stay compliant with laws and regulations. They provide reassurance that we are operating to a high-level, and confidence that we have been independently assessed. They demonstrate our competence to design and deliver your training space, covering key areas such as equipment design and manufacture and on-site installation work.



LEAD TIMES

All our manufactured items are made to order and are subject to a lead-time of around 4-8 weeks.

Small equipment that's stocked in our warehouse can normally be dispatched on a next day basis, depending on location.

Please contact us on 01455 890 100 for up-to-date information.

INSTALLATION

Our friendly and professional install teams are fully trained and qualified for site work and will take care of everything; from laying the flooring, to unwrapping, building and positioning the equipment, and taking care of any floor or wall fixings along the way, always using appropriate fixing materials and methods.



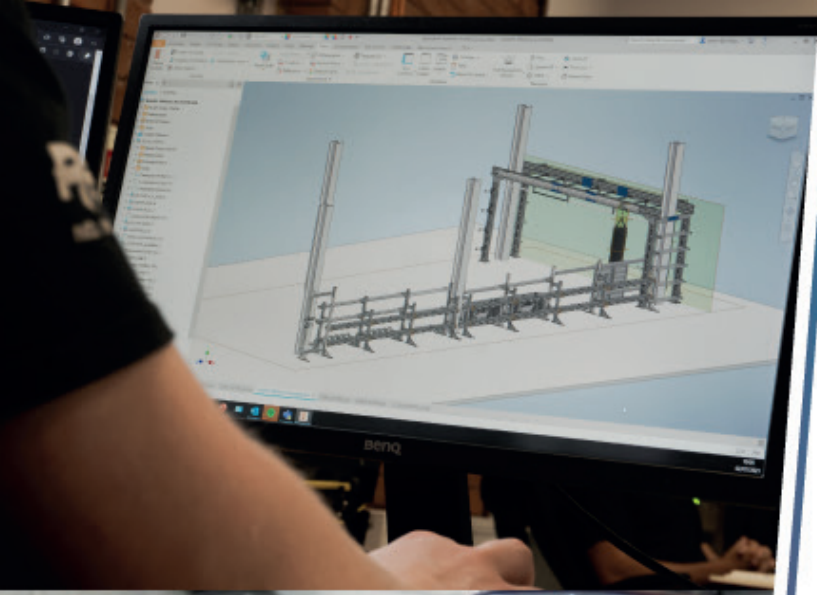

FINANCE

Equipment leasing is a fantastic way of getting finance for brand new equipment on terms which are far more favourable than traditional bank lending. Whether you are an established gym or leisure facility, a new starter, or a personal trainer, we can help provide the gym and equipment you need. Please contact us for more details.

CUSTOMER SERVICE AND SUPPORT

All our products are supported by industry leading warranties. However, if you do experience any issues, you can contact our support department on: 01455 890 100 or email support@indigofitness.com.

We also offer a range of service contracts so you can be assured your equipment will be routinely checked and kept in top working order. Please talk to our sales team for more information.

OFFICIAL SUPPLIERS AND PARTNERSHIPS

We work closely with many people and organisations across a range of sectors and are proud to be officially recognized as strength and conditioning partners and equipment suppliers to; Leeds Rhinos RFC, Wasps Rugby, The Matt Hampson Foundation, and Gamechanger Performance. We are also contract holders for the supply of physical training equipment to the British Army.





EXAMPLES OF OUR WORK





AN INTRODUCTION TO

RAZE

RAZE is our very own brand of strength and conditioning equipment.

It's all designed and engineered from our HQ in the UK, and most of it is also manufactured there. It combines our passion for high quality, functional equipment with our experience in manufacturing.

You work hard. You train hard. You want to know your equipment will back you up 100% of the time. With RAZE you can.



RAZE Shadow Series is a modular system that's been designed to fit your budget without compromising on aesthetics or functionality.

SHADOW
SERIES

The rack, rig, and storage systems can all be combined to create compact, multifunctional units - removing the need for many separate pieces of equipment. Our UK design and engineering team can also create custom units, designed specifically to fit your space and needs.



Engineered for the demands of modern strength coaches and elite athletes, the RAZE Zenith Series system will take your training to another level.

ZENITH
S E R I E S

It's also perfect for functional training spaces and can be a central 'hub' for group training activities. The Zenith Series can also be customised to provide you with a tailored training solution.



RACKS

SHADOW SERIES

Highly modular design with every function and feature you are likely to need from a rack. - It's a rock solid performer that's built to last.

Key Features:

- 70mm x 70mm x 3mm uprights
- Adjustable height bar rests with two-points locking system for safety, and HDPE inserts to protect your bar
- Precision laser cut numbered holes, spaced every 50mm
- Pull up bar
- 8 weight holder posts
- Combines with the Shadow series storage and rig systems

ZENITH SERIES

The ultimate progression of our racks range. Designed and engineered for the demands of modern strength coaches and elite athletes, the zenith series takes training to the next level.

Key Features:

- Sturdy 160mm x 80mm x 5mm uprights
- Precision laser cut numbered holes, spaced every 60mm
- Bar hooks and spot arms contain protective HDPE to protect bars
- Pull up bar
- 12 weight holder posts
- 2 integrated bar holders
- Band peg locations as standard



PERSONALISATION

All of our racks are manufactured to order, giving you the opportunity to fully customise elements of the design, choose your colour scheme, and add your logo.

Frame colours are available in matt, gloss and textured finishes, and you can even choose more than one colour, allowing you to create something really eye catching and unique for your training space.

Framework colours

- Light Blue RAL5015
- Dark Blue RAL5002
- White RAL9016
- Purple RAL4006
- Silver Sparkle
- Silver RAL9006
- Green RAL6018
- Red RAL3020
- Unfinished Steel
- Yellow RAL1023
- Orange RAL2004
- Dark Grey RAL7024
- Black Texture
- Black RAL9005

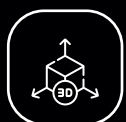

Full 3D Design



Powder Coated



Lifetime Warranty



Premium Steel



Custom Colour



Laser Cut



British Built

RACKS

SHADOW SERIES

U5009



Squat Stands (Pair)

D: 940mm W: 470mm H: 1940mm

U5009W



Wall Rack

D: 900mm W: 1310mm H: 2461mm

U5009A



Half Rack

D: 900mm W: 1737mm H: 2461mm

U5009C



Full Rack

D: 1600mm W: 1737mm H: 2461mm

U5009E



Integrated Hi/Lo Stack

D: 1000mm W: 350mm H: 2460mm

U5009F



Integrated Pulldown Row Stack

D: 1550mm W: 1150mm H: 2460mm

U5005A

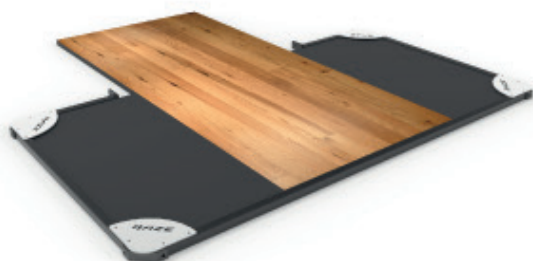

Integrated Platform (Wooden Centre)

D: 1300mm (in front of rack) W: 2290mm

U5005A1

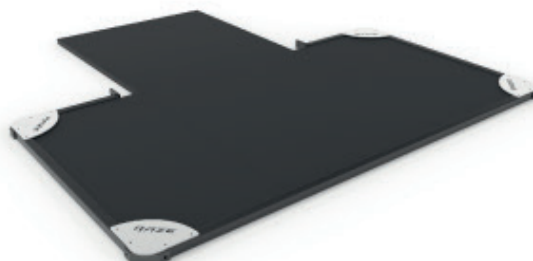

Integrated Platform (Rubber Centre)

D: 1300mm (in front of rack) W: 2290mm

SHADOW SERIES ATTACHMENTS

U5009
A06L&R



Bar Hooks (Pair)

U5009
A03L&R



External Spot Arms (Pair)

U5009
A80



Internal Spot Arms (Pair)

U5009-A09



Adjustable Dip

U5009-A19



Adjustable Step

61420



Band Pegs (Pair)

U5009-A75



**Full Rack Band
Peg Attachment**

U5009-A74



**Half Rack Band
Peg Attachment**

U5009-A14



Rope Hoop Attachment

U3009-A46B_32



Standard Pull Up Bar

U5009-A16



Grapppler

RACKS

ZENITH SERIES

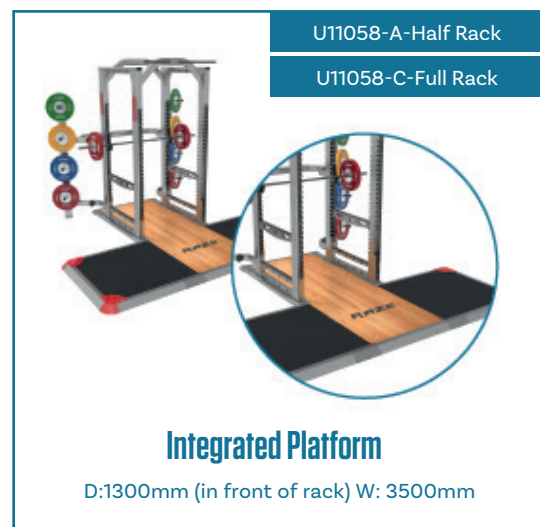

ZENITH SERIES ATTACHMENTS

1.8m - U1108-A12
2.4m - U1108-A12A
3.0m - U1108-A12B



Rack Link Bars

U1108-A10



Bar Hooks (Pair)

U1108-A11



Adjustable Dip

U1108-A17



External Safety Spot Arms (Pair)

U1108-A13



Internal Safety Spot Arms (Pair)

U1108-A04



Technique Trays (Pair)

U1108-A21



Adjustable Prone Row Bench

U1108-A14



Adjustable Step

U1108-A07



Olympic Bar Holder

U1108-A18



Isometric Bars (Pairs)

61421



Resistance Band Pegs (Pair)

61429



Resistance Band Storage

61422



Prone Row Bench Storage

61425



Gym Ball Holder

61419



Grappler

61426



Single Leg Squat Attachment

61424



Med Ball Storage



RIGS

SHADOW SERIES

The Shadow Series rig is an ideal set up for affiliates. It has been designed as a modular construction - using connectable 'cells' you can easily build a rig to suit your needs perfectly.

Key Features:

- 70mm x 70mm x 3mm uprights
- Adjustable height bar rests with two-points locking system for safety, and HDPE inserts to protect your bar
- Precision laser cut numbered holes, spaced every 50mm
- Wide range of attachments
- Combines with the Shadow series storage and Rack systems

ZENITH SERIES

Perfect for a functional training space, the Zenith Series Rig can be customized to provide all the tools required for effective full body workouts and provides the ideal hub for group training.

Key Features:

- Oversize 200mm x 100mm x 5mm uprights
- Supplied with monkey bars as standard, all other parts additional
- Wide range of attachments
- Combines with Zenith Series storage and Rack systems



PERSONALISATION

All our Rigs are manufactured to order, giving you the opportunity to customize elements of the design, choose your colour scheme, and add your logo.

All of our frame colours are available in gloss or matte finishes, and you can even choose more than one colour, allowing you to create something really eye-catching and unique for your training space.



Full 3D Design



Powder Coated



Lifetime Warranty



Premium Steel



Custom Colour



Laser Cut



British Built

SHADOW SERIES

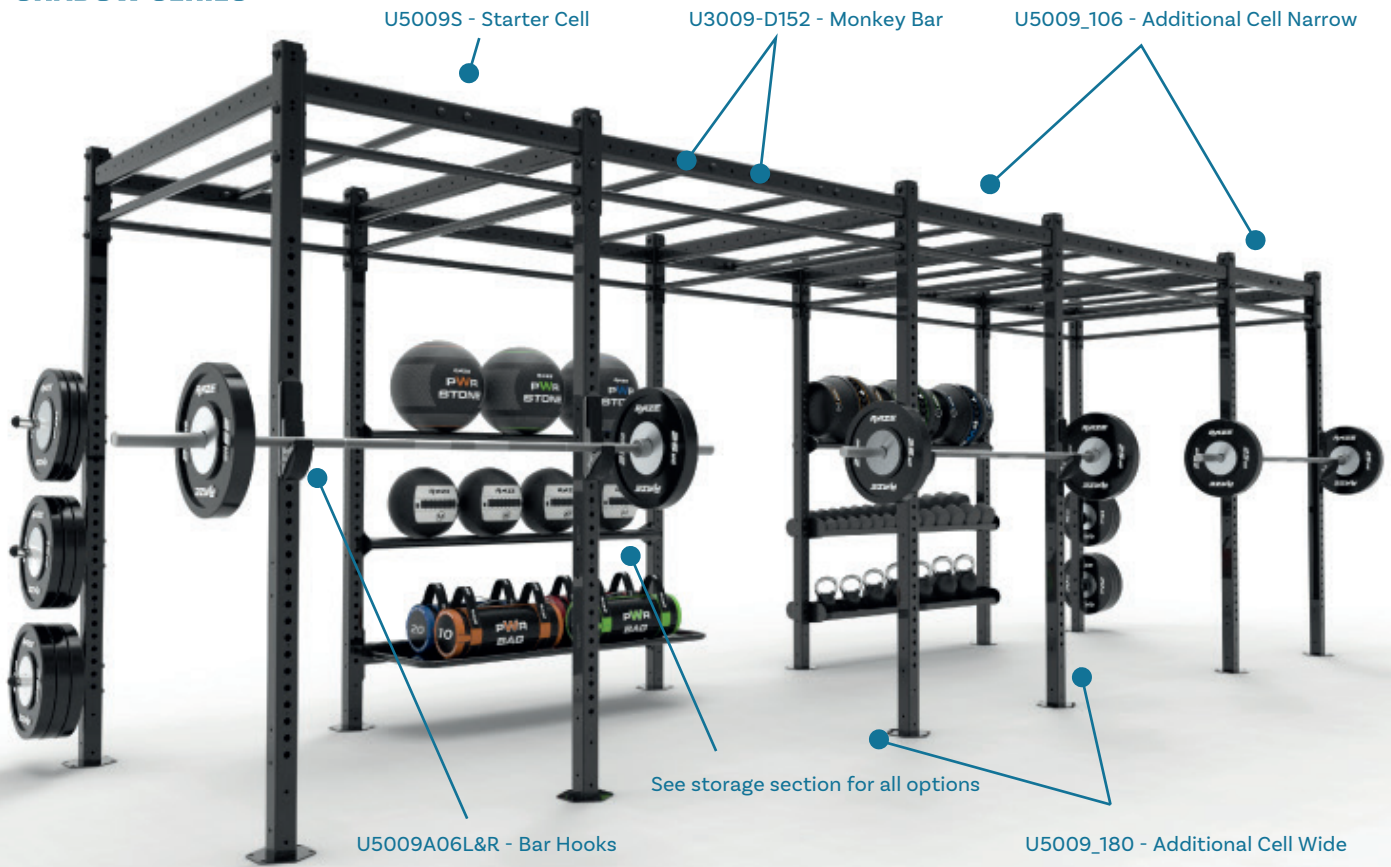

SHADOW SERIES ATTACHMENTS

U5009-A44



High Bar

U5009-A09



Adjustable Dip

U5009-A19



Adjustable Step

RRT



**Revvll Attachment
(Adjustable)**

RRT-H



**Revvll Attachment
(Fixed)**

U5009-A16



Grappler

U5009-A14



Rope Hoop Attachment

1060mm - U5009-WB2_106
1060mm - U5009-WB2_150
1060mm - U5009-WB2_180



Wing

U5009-A35



Vertical Ball Target

61423



Horizontal Ball Target

U3009-A14C



**Compact Punch
Bag Bracket**

U5009-A51_75
U5009-WB2_106



Ball Grip Pull Up

32mm - U5009-A46A_32
38mm - U5009-A46A_38
48mm - U5009-A46A_48



Muscle Up Bar

U3009-A40



Box Pull Up Bar

U3009-A46B_32



Standard Pull Up Bar

U5009-A05



**Standard Punch
Bag Arm**

MONSTER RIG

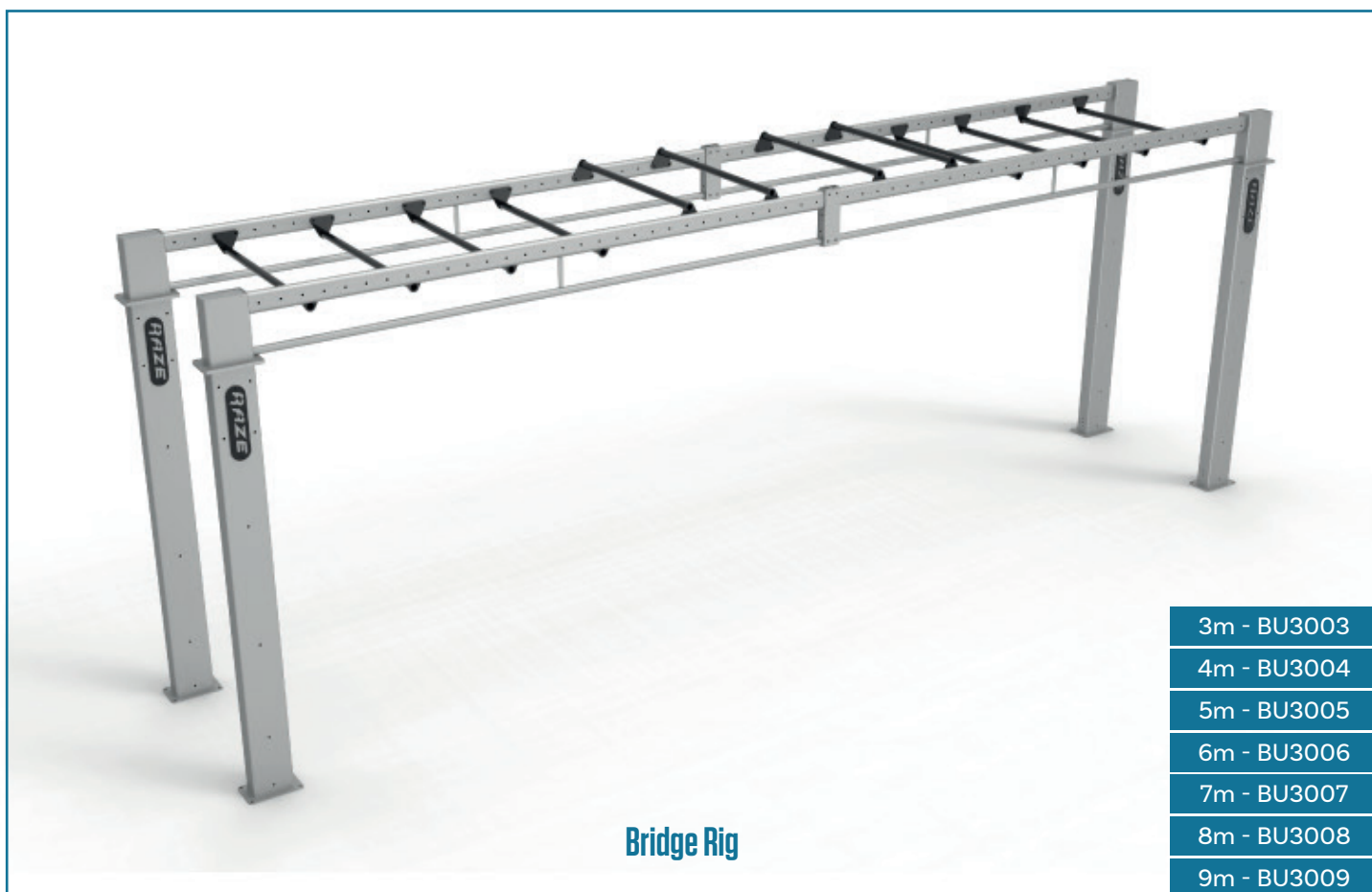
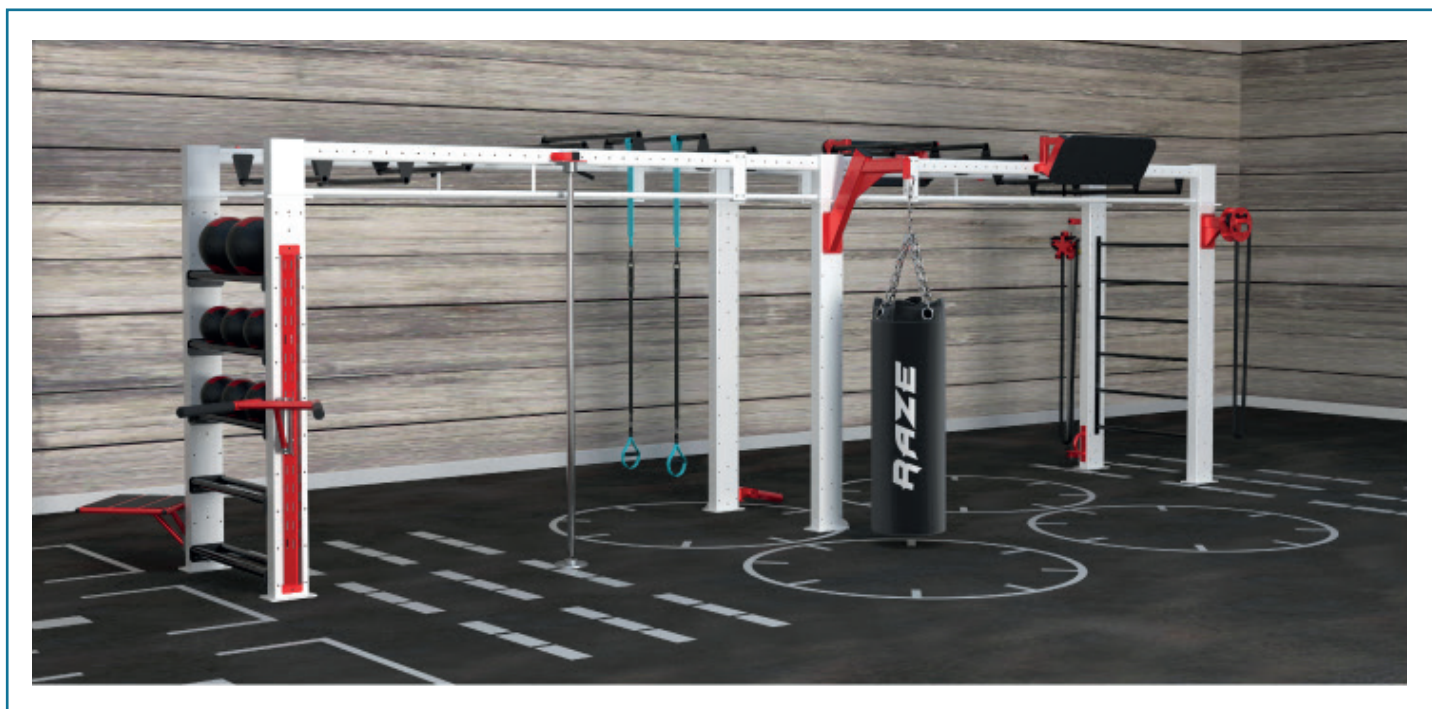

ZENITH SERIES ATTACHMENTS

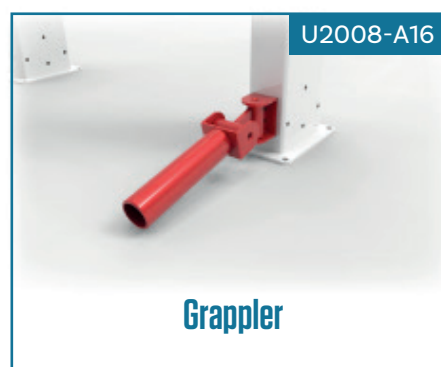



STORAGE

Keep your training space neat and tidy with our modular storage systems. Designed so you can create a solution to meet your own space constraints and equipment mix. Putting one together is really easy - all you need to do is:

01

Choose your legs, from either the Shadow or Zenith Series. The Zenith Series has the advantage of being able to add training functionality with a pull up bar or suspension trainer mount.

02

Choose your storage shelves and bolt on storage options (compatible with any leg). Shelves are available in 3 lengths (1000mm, 1500mm, 1800mm).

Our storage solutions also combine with products from the racks and rigs ranges, meaning you can create a tailored solution for your whole training space that maintains the same visual styling.

Our sales team will be more than happy to draw up a bespoke solution for you, just get in touch: 01455 890 100 or sales@indigofitness.com



PERSONALISATION

All our modular storage is manufactured to order, giving you the opportunity to customize elements of the design, choose your colour scheme, and add your logo.

Frame colours are available in matt, gloss, and textured finishes, and you can even choose more than one colour, allowing you to create something really eye catching and unique for your training space.



Full 3D Design



Powder Coated



Lifetime Warranty



Premium Steel



Custom Colour



Laser Cut



British Built

LEGS & JOINERS

U5009-A01SS



Shadow Short Leg

U5009-A01TS



Shadow Standard Leg

U5009W-A01TS



Shadow Standard Leg
Wall Fix

60537



Zenith Short Leg

61110



Zenith Standard Leg

60525



Zenith Functional Leg

61111

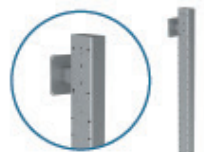

Zenith Standard Leg
Wall Fix

60100



Zenith Functional Leg
Wall Fix

1000mm: U5009-H100

1500mm: U5009-H150

1800mm: U5009-H180



Shadow Series - Leg Joining Bar

1000mm: BU3100-A05_WL_1000

1500mm: BU3100-A05_WL_1500

1800mm: BU3100-A05_WL_1800



Zenith Series - Leg Joining Bar

1000mm: BU3100-A16_100

1500mm: BU3100-A16_150

1800mm: BU3100-A16_180



Zenith Series - Suspension Bar

1000mm: BU3100-A17_100

1500mm: BU3100-A17_150

1800mm: BU3100-A17_180



Zenith Series - Pull Up Bar

STORAGE OPTIONS

1000mm: U6003-RS01-1000

1500mm: U6003-RS01-1500

1800mm: U6003-RS01-1800



Rail Shelf

1000mm: U6003-NF01-1000

1500mm: U6003-NF01-1500

1800mm: U6003-NF01-1800



Narrow Flat Shelf

1000mm: U6003-WF01-1000

1500mm: U6003-WF01-1500

1800mm: U6003-WF01-1800



Wide Flat Shelf

1000mm: U6003-NI01-1000

1500mm: U6003-NI01-1500

1800mm: U6003-NI01-1800



Narrow Incline Shelf

1000mm: U6003-WO01-1000

1500mm: U6003-WO01-1500

1800mm: U6003-WO01-1800



Wide Open Shelf

1000mm: U6003-BU01-1000

1500mm: U6003-BU01-1500

1800mm: U6003-BU01-1800



Bosu Ball Rack

1000mm: U6003-SD01-1000

1500mm: U6003-SD01-1500

1800mm: U6003-SD01-1800



Studio Dumbbells Rack

1000mm: U6003-BB01-1000

1500mm: U6003-BB01-1500

1800mm: U6003-BB01-1800



Bulgarian / Powerbag Shelf

1000mm: U6003-PS01-1000

1500mm: U6003-PS01-1500

1800mm: U6003-PS01-1800



Plate Storage - Toast Rack

1000mm: U6003-PS02-1000

1500mm: U6003-PS02-1500

1800mm: U6003-PS02-1800



Plate Storage - Pegs

1000mm: U6003-MH01-1000

1500mm: U6003-MH01-1500

1800mm: U6003-MH01-1800



Matt Hanger

1000mm: U6003-BG01-1000

1500mm: U6003-BG01-1500

1800mm: U6003-BG01-1800



Boxing Glove Shelf

STORAGE OPTIONS

	1000mm: U6003-FB01-1000
	1500mm: U6003-FB01-1500
	1800mm: U6003-FB01-1800

Fixed Barbell Rack

	(4DB) 1000mm: U6003-DB01-1000
	(6DB) 1500mm: U6003-DB01-1500
	(7DB) 1800mm: U6003-DB01-1800

Incline DB Saddle Rack

	1000mm: U6003-SW01-1000
	1500mm: U6003-SW01-1500
	1800mm: U6003-SW01-1800

5 & 10kg Studio Weight Rack

	1000mm: U6003-SW02-1000
	1500mm: U6003-SW02-1500
	1800mm: U6003-SW02-1800

1.25 & 2.5kg Studio Weight Rack

	1000mm: U6003-SC01-1000
	1500mm: U6003-SC01-1500
	1800mm: U6003-SC01-1800

Studio Collars Rack

	1000mm: U6003-SBAR01-1000
	1500mm: U6003-SBAR01-1500
	1800mm: U6003-SBAR01-1800

Studio Bars Rack

	1000mm: U6003-DG01-1000
	1500mm: U6003-DG01-1500
	1800mm: U6003-DG01-1800

Drag Bag Shelf

	1000mm: U6003-US01-1000
	1500mm: U6003-US01-1500
	1800mm: U6003-US01-1800

Utility Shelf

STORAGE OPTIONS

1000mm: U6003-SB01-1000

1500mm: U6003-SB01-1500

1800mm: U6003-SB01-1800



Storage Bin

1000mm: U6003-SB01-1000D

1500mm: U6003-SB01-1500D

1800mm: U6003-SB01-1800D



Storage Bin W / Dividers

1000mm: U6003-SB01-1000L

1500mm: U6003-SB01-1500L

1800mm: U6003-SB01-1800L



Storage Bin W / Lid

1000mm: U6003-SB01-1000LD

1500mm: U6003-SB01-1500LD

1800mm: U6003-SB01-1800LD



Storage Bin W / Lid & Dividers

Right: U6003-MHR01

Left: U6003-MHL01



Side Loading Mat Hanger

U6003-GB01



Side Fixing Gymball

U6003-PS01



Side Loading Plate Storage

U6003-BS01



Side Loading Band / Cord Storage

U6003-BS02



Front Loading Band / Cord Storage

U6003-OB01



Single Olympic Bar Hanger

U6003-OB03



Triple Olympic Bar Hanger

U6003-BR01



Battle Rope Storage

CONFIGURATION GUIDE

To help with creating your own storage solutions below are some examples with details of which products were used to create them.

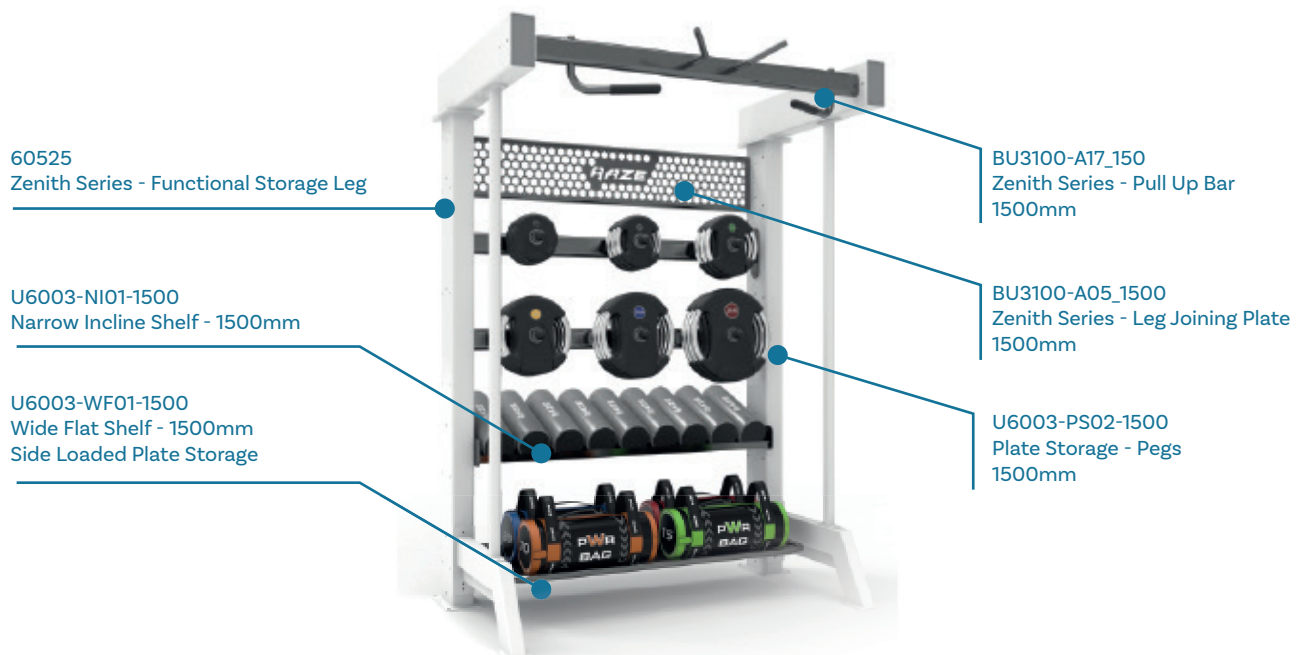

STAND ALONE STORAGE



U089B-R

Wall Fix Vertical Plate Storage Rack (6 pin)



U089C-R

Floor Standing Vertical Plate Storage Rack (6 pin)



U089-R

Olympic Weight Tree



230138

RAZE Horizontal Plate Rack (5 Pair: 5kg-25kg)



U222-R

Mat Storage Wall Mounted



U202-R

Powerbag Rack Vertical (Holds 4)



U218-R

Foam Roller Holder Wall Mounted



230034

RAZE Kettlebell Rack



230033

RAZE 5 Ball Med Ball Rack



U243-RA5

RAZE 5 Bar Box Storage



U243-RB6

RAZE 6 Bar Linear Storage



230143

RAZE 2 Tier DB Saddle Rack Extension Leg



U098

Olympic Bar Holder



U243-RC9

RAZE 9 Bar Box Storage



U243-RD

RAZE 5 Bar Gun Rack



5 Pair: 230139

6 Pair: 230140

RAZE 2 Tier DB Saddle Rack



5 Pair: 230141

6 Pair: 230142

RAZE 2 Tier DB Saddle Rack Extension Trays

STRENGTH & CONDITIONING

 **MADE IN
BRITAIN**



R-SPORT

Well specified budget equipment that provides an excellent entry level into the world of strength training.

SHADOW

SERIES

Take your training to the next level - Shadow Series offers the perfect balance between durability and affordability.

ZENITH

SERIES

When only the best will do, look no further than Zenith Series - our competition level of strength training equipment.

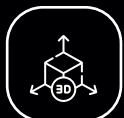

Full 3D Design



Powder Coated



Lifetime Warranty



Premium Steel



Custom Colour



Laser Cut



British Built

STRENGTH & CONDITIONING

PLATES

R-SPORT

Bumper Plate



5kg	230456
10kg	230457
15kg	230458
20kg	230459
25kg	230460

R-SPORT

Bumper Plate



10kg	230461
15kg	230462
20kg	230463
25kg	230464

SHADOW

Bumper Plate



5kg	230001
10kg	230002
15kg	230003
20kg	230004
25kg	230005

SHADOW

Bumper Plate



10kg	230006
15kg	230007
20kg	230008
25kg	230009

ZENITH

Competition Bumper Plate



10kg	230445
15kg	230446
20kg	230447
25kg	230448

Technique Bumper Plate



1.5kg	60140
2.5kg	60141
5kg	60142

Rubber Grip Plate

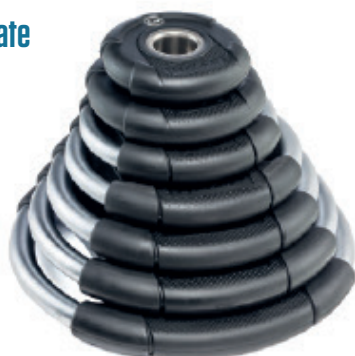

1.25kg	230035	15kg	230039
2.5kg	230036	20kg	230040
5kg	230037	25kg	230041
10kg	230038		

BARS

	230518	230519
	Men's R-Sport Bar L: 2200mm W: 710mm H: 210mm Weight: 35kg	Women's R-Sport Bar L: 2200mm W: 710mm H: 210mm Weight: 35kg

	230525	230535
	Men's Shadow Series Bar L: 2200mm W: 710mm H: 210mm Weight: 35kg	Women's Shadow Series Bar L: 2200mm W: 710mm H: 210mm Weight: 35kg

	230526
	Men's Zenith Series Bar L: 2200mm W: 710mm H: 210mm Weight: 35kg

	230116
	Technique Bar L: 2200mm W: 710mm H: 210mm Weight: 35kg

230117

Deadlift Bar

RB33001

Axle Bar
L: 2200mm W: 80mm H: 80mm Weight: 35kg

RB33002

Trap Bar
L: 2200mm W: 710mm H: 210mm Weight: 35kg

RB33003

Multi-Grip Bar
L: 2200mm W: 80mm H: 200mm Weight: 20kg

RB33004

Cambered Bar
L: 2200mm W: 80mm H: 415mm Weight: 35kg

RB33005

Safety Squat Bar
L: 2200mm W: 160mm H: 515mm Weight: 35kg

RB33006

Angled Multi-Grip Bar
L: 2200mm W: 80mm H: 200mm Weight: 20kg

STRENGTH & CONDITIONING

WEIGHTLIFTING ACCESSORIES

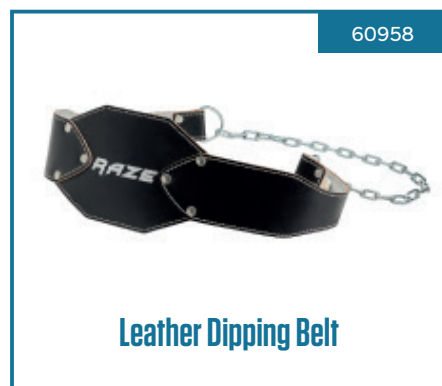
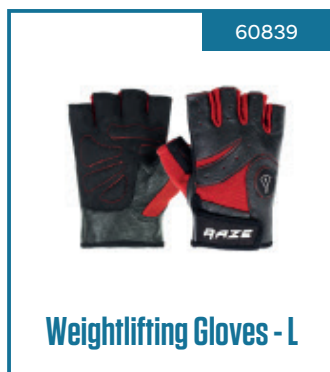
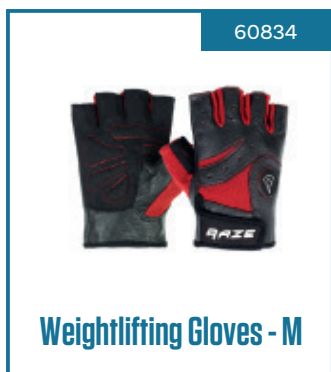
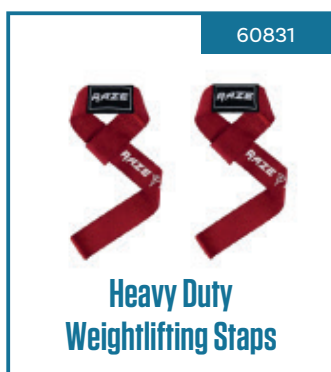

STRENGTH



U1004
U1004A

Shadow Series Deadlift Platform
L: 2500mm W: 1300mm H: 400mm
L: 2500mm W: 2500mm H: 400mm

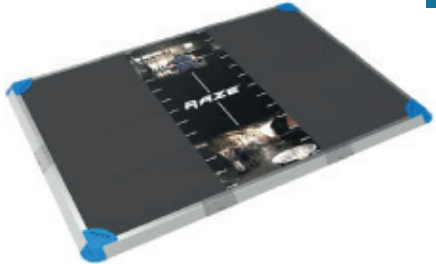

U1105A

Zenith Series Deadlift Platform
L: 3600mm W: 2600mm H: 700mm



60143

Wooden Jerk Box Set



U5009-A62

The Wall



RS13001

Yoke



RS13002

Farmers Walk Handles



RS13003

Deadpull Stands



PU Dumbbells

2.5kg	230494	17.5kg	230500	32.5kg	230506	47.5kg	230512
5kg	230495	20kg	230501	35kg	230507	50kg	230513
7.5kg	230496	22.5kg	230502	37.5kg	230508	52.5kg	230514
10kg	230497	25kg	230503	40kg	230509	55kg	230515
12.5kg	230498	27.5kg	230504	42.5kg	230510	57.5kg	230516
15kg	230499	30kg	230505	45kg	230511	60kg	230517

STRENGTH & CONDITIONING

CONDITIONING

Rubber Kettlebell



4kg	230052	20kg	230058
6kg	230053	24kg	230059
8kg	230054	28kg	230060
10kg	230055	32kg	230061
12kg	230056	36kg	230062
16kg	230057		

Dual Grip Med Ball



4kg	230016	10kg	230020
5kg	230017	8kg	230021
6kg	230018	9kg	230022
7kg	230019		

Med Ball



1kg	230023	6kg	230028
2kg	230024	7kg	230029
3kg	230025	8kg	230030
4kg	230026	9kg	230031
5kg	230027	10kg	230032

Wall Ball



4kg	230450	9kg	230453
6kg	230451	10kg	230454
8kg	230452	12kg	230455

Slam Ball 2.0



4kg	230485	10kg	230488
6kg	230486	12kg	230489
8kg	230487	14kg	230490

STRENGTH & CONDITIONING

CONDITIONING

230131



Gymnastic Rings (28mm)

WOODEN 230130



Gymnastic Rings (32mm)

60397



Suspension Trainer - Blue

60526



Suspension Trainer - Pink

U246-R



Speed Sled

U245-RB



Dog Sled (Short Handle)

U245-RA



Dog Sled (Long Handle)

U221-R



Prowler Sled

U203-R



Core Plate

U203-RA



Double Core Trainer

230132



Wooden 3 in 1 Plyo Box
(30" x 20" x 24")

230129



Metal Bracket Loop Attachment

U233-R



Rope Island (6 Ropes)

30" 230127
50" 230128



Battle Rope with Sleeve

230465



Soft 3 in 1 Plyo Box
(30" x 20" x 24")

Soft Plyo Box



3"	230133
6"	230134
12"	230135
18"	230136
24"	230137

Battle Rope



30"	230125
50"	230126

STRENGTH & CONDITIONING

ACCESSORIES & BANDS

230484



Excercise Mat
(1000x610x10mm)

230384



Ab Mat

230386



Speed Rope

230385



Foam Roller 45cm

230387



Multi-Point Foam Roller 33cm

0.3mm	230528
0.7mm	230529
1.0mm	230530
1.2mm	230531



9" Mini Band

6.5mm	230016
13mm	230017
22mm	230018
28mm	230019
44mm	230017
63mm	230018
83mm	230019



41" Power Band

38mm	230018
50mm	230019



74" Agility Band

STRENGTH & CONDITIONING

	15KG Black: 60766
	20KG Black: 60767

Raptor Weight Vest - Black



	15KG Camo: 60765
	20KG Camo: 60768

Raptor Weight Vest - Camo



	Small: 60313
	Med: 60314
	Large: 60315

Silverback Harness

	60344
--	-------

Silverback 3M Resistance Band

	One: 61044
	Pro: 60763

REVVLL Rope trainer

	2M: U241-R2
	3M: U241-R3

ProLog M-Spec

	1: RX2100
	2: RX2300
	3: RX2500

Ropeflex

PWR TOOLS



10KG - 60548
15KG - 60376
20KG - 60377
25KG - 60378
30KG - 60379
35KG - 60380

BALE

10KG - 60389
15KG - 60390
20KG - 60391
25KG - 60392
30KG - 60393
35KG - 60394
40KG - 60395

KEG

60461

PAD

5KG - 60824
10KG - 60825
15KG - 60826
20KG - 60827
25KG - 60828
30KG - 60829
35KG - 60830
40KG - 60881
45KG - 60882
50KG - 60883

POWERBAG

10KG - 61225
20KG - 61226
30KG - 61227

ARMOUR BAG

CARDIO

61123



Cascade Climber

EPM5-BLK



Concept 2 Rower

Ski-Erg PM5



Concept 2 Ski Erg

WATTBIKEPRO



Wattbike Pro

CARDIO

ST8000B-YT09AV-08



Spirit CT800 Treadmill

L: 1905mm W: 1270mm H: 1675mm Weight: 250kg

XE890-AE10K-19P



Spirit CE800 Elliptical

L: 2125mm W: 885mm H: 1440mm Weight: 155kg

XU878-AB05K-17M



Spirit CU800 Upright Bike

L: 1080mm W: 550mm H: 1360mm Weight: 155kg

ST8800-ST006-01F



Spirit CT900 Treadmill

L: 2140mm W: 903mm H: 1530mm Weight: 227kg

SE8800-SE026-01E



Spirit CE900 Elliptical

L: 1953mm W: 820mm H: 1685mm Weight: 180kg

SU8800-SB008-01E



Spirit CU900 Upright Bike

L: 1212mm W: 363mm H: 1394mm Weight: 64.5kg

Renegade

BUILT FOR H.I.I.T

BIKE 230476

- Built to withstand anything that's thrown at it, the Renegade Bike is one tough competitor.
- Stay motivated with 8 workout modes, including 10/20 and 20/10 intervals.
- Industrial grade, sealed cartridge bearings on all moving joints for long lasting durability and smooth and quiet action.

L: 1230mm W: 680mm H: 1390mm Weight: 70kg



RUNNER 230479

- A treadmill like no other, the Renegade Runner uses no power or motors, running entirely on your own drive and energy, delivering max calorie burn.
- Change speed at will, no need to press buttons and wait for the motor to speed up or slow down.
- Low maintenance - no belt tension to adjust, no decks or motors to replace.

L: 1830mm W: 930mm H: 1580mm Weight: 152kg



ROWER 230473 - Manual 230474 - Digital

- A real animal of rower - 8 selectable levels of strong resistance are delivered using a combination of air and magnets.
- Steel reinforced aluminium seat track.
- Stands upright for storage
- Available in manual or digital versions

L: 2240mm W: 620mm H: 620mm Weight: 49kg



CARBON CLAW

SERIES 5



Hook & Jab Pads

Red | U | CC-184

SERIES 5



Hook & Jab Pads

Green | U | CC-036

SERIES 5



Hook & Jab Pads

Orange | U | CC-282

SERIES 5



4ft / 30-27kg Punch Bags

Black/Red | 30kg | 4ft | CC-185A

Black/Green | 27kg | 4ft | CC-043A

Black/Orange | 27kg | 4ft | CC-289A

*these Punchbags include swivel fixing

SERIES 5



Gloves

Red | 12oz | CC-177

Red | 14oz | CC-178

Red | 16oz | CC-179

SERIES 5



Gloves

Green | 12oz | CC-028

Green | 14oz | CC-029

Green | 16oz | CC-030

SERIES 5



Gloves

Orange | 12oz | CC-274

Orange | 14oz | CC-275

Orange | 16oz | CC-276

SERIES 7



3ft Pro Punch Bag Bracket

Black | 75kg | 3FT **CC-575**

SERIES 7



Swivel Fixing

Chrome | 75kg max **CC-155**

SERIES 7



Punch Bag Chain Set

Chrome | 60kg | 4 Strand **CC-080**
 Chrome | 75kg | 6 Strand **CC-154**

SERIES 7



Elasticated Inner Mitt

Red | S/M | Pack of 6 Pairs **CC-186**
 Black | S/M | Pack of 6 Pairs **CC-187**

SERIES 7



4ft / 45kg Technique Bag

Black | 45kg | 4.6ft x 14" **CC-223A**

SERIES 7



Bag Gloves

Black/White | 12oz **CC-051**
 Black/White | 14oz **CC-052**
 Black/White | 16oz **CC-053**

SERIES 7



Hook / Jab Pads

Black/White | U **CC-069**

SERIES 7



7' Speed Ball

Black/White | 7" **CC-072**

SERIES 7



Multi Height Adjust Speed Ball Frame

Speedball frame inc fixings **CC-576**
 Speedball frame inc Mtg Plate & fix **CC-577**

SERIES 7



4ft / 30kg Punch Bag

Black/White | 30kg | 4ft x 13.5" **CC-074A**

STRENGTH STATION

 **MADE IN
BRITAIN**

PERSONALISATION

Building on over 20 years of design, innovation and engineering excellence, our range of station strength equipment offers a highly effective strength solution delivered in an aesthetically pleasing and biomechanically correct package.

All equipment is made to order, allowing you to choose frame and upholstery colours and branding options.



Full 3D Design



Powder Coated



Lifetime Warranty



Premium Steel



Custom Colour



Laser Cut



British Built

STATION STRENGTH

SELECTORISED MACHINES

LOWER BODY **R001**



Leg Press
L: 1905mm W: 1270mm
H: 1675mm Weight: 250kg

LOWER BODY **R002**



Leg Ad / Abductor
L: 1420mm W: 1180mm
H: 1495mm Weight: 220kg

LOWER BODY **R003**



Seated Leg Curl
L: 1360mm W: 1150mm
H: 1515mm Weight: 240kg

LOWER BODY **R004**



Leg Extension
L: 990mm W: 1150mm
H: 1515mm Weight: 250kg

LOWER BODY **R005**



Prone Leg Curl
L: 1400mm W: 900mm
H: 1700mm Weight: 240kg

LOWER BODY **R010**



Leg Extension Curl
L: 1350mm W: 1130mm
H: 1515mm Weight: 240kg

UPPER BODY **R010**



Lat Pulldown
L: 1905mm W: 1270mm H: 1675mm Weight: 250kg

UPPER BODY **R011**



Seated Back
L: 1600mm W: 1280mm H: 1940mm Weight: 260kg

SELECTORISED MACHINES

UPPER BODY R012



Back Extension
L: 1140mm W: 930mm
H: 1525mm Weight: 220kg

UPPER BODY R013



Low Pulley Row
L: 3000mm W: 7500mm
H: 2300mm Weight: 230kg

UPPER BODY R021



Shoulder Press
L: 1420mm W: 1180mm
H: 1495mm Weight: 220kg

UPPER BODY R022



Pec Fly / Rear Deltoid
L: 1385mm W: 1485mm
H: 1730mm Weight: 320kg

UPPER BODY R062



Lat Pulldown / Low Row
L: 2245mm W: 1490mm
H: 2245mm Weight: 290kg

UPPER BODY R020



Chest Press
L: 1245mm W: 1335mm
H: 1890mm Weight: 230kg

UPPER BODY R061



Multipress
L: 1245mm W: 1335mm H: 1890mm Weight: 290kg

UPPER BODY R030



Arm Curl
L: 1345mm W: 1010mm H: 1570mm Weight: 240kg

STATION STRENGTH

SELECTORISED MACHINES

UPPER BODY

R031



Tricep Dipping

L: 1140mm W: 930mm H: 1525mm Weight: 220kg

UPPER BODY

R064



Bicep / Tricep

L: 1650mm W: 1250mm H: 1650mm Weight: 190kg

UPPER BODY

R052



Assisted Chin Dip

L: 1200mm W: 1210mm H: 2200mm Weight: 280kg

UPPER BODY

R032

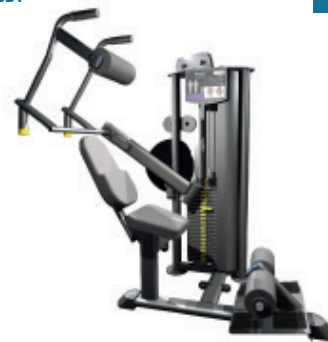

Abdominal

L: 3000mm W: 750mm H: 2300mm Weight: 240kg

PULLEY

R058



Hi / Low Pulley

L: 750mm W: 850mm H: 2200mm Weight: 180kg

PULLEY

R053



Multiple Pulley

L: 750mm W: 1050mm H: 2170mm Weight: 210kg

SELECTORISED MACHINES

PULLEY

R055



Compact Dual Adjustable Pulley

L: 1625mm W: 800mm H: 2290mm Weight: 400kg

PULLEY

R059



Cable Crossover

L: 3255mm W: 1015mm H: 2295mm Weight: 380kg

PULLEY

R050



Dual Multiple Pulley

L: 2530mm W: 800mm H: 2150mm Weight: 440kg

PULLEY

R101



4 Stack Multi-Station

L: 3610mm W: 1640mm H: 2425mm

PULLEY

R101A



4 Stack Double Row / Double Pulldown

L: 3610mm W: 3610mm H: 2425mm

PULLEY

R102



5 Stack Multi-Station (Cable Crossover)

L: 1905mm W: 1270mm H: 1675mm Weight: 250kg

STATION STRENGTH

IFI MACHINES



R003i



Inclusive Seated Leg Curl

L: 1515mm W: 1215mm
H: 1435mm Weight: 260kg

R004i



Inclusive Leg Extension

L: 1440mm W: 1025mm
H: 1435mm Weight: 250kg

R001i



Inclusive Leg Press

L: 1515mm W: 1215mm
H: 1435mm Weight: 260kg

R010i



Inclusive Lat Pull Down

L: 1640mm W: 1400mm
H: 2220mm Stack: 100kg

R011i



Inclusive Seated Back / Row

L: 1550mm W: 1280mm
H: 1940mm Stack: 100kg

R021i



Inclusive Shoulder Press

L: 1830mm W: 1400mm
H: 1570mm Weight: 210kg

R022i



Inclusive Pec Fly / Rear Deltoid

L: 1385mm W: 1485mm
H: 1730mm Weight: 320kg

R020i



Inclusive Chest Press

L: 1500mm W: 1410mm
H: 1890mm Weight: 220kg

R053i



Inclusive Multiple Pulley

L: 1120mm W: 1360mm H: 2170mm Weight: 220kg

R050i



Inclusive Dual Multiple Pulley

L: 1220mm W: 1360mm H: 2170mm Weight: 365kg

PLATE LOADED

LOWER BODY

U006-R



Seated Calf

L: 1400mm W: 500mm H: 900mm

LOWER BODY

U011



45° Calf Raise

L: 1000mm W: 700mm H: 1800mm

LOWER BODY

L016-R



Iso Lever Squat

L: 1600mm W: 1300mm
H: 1800mm Weight: 180kg

LOWER BODY

LO09-R



Iso Lever Leg Extension

L: 1050mm W: 1400mm
H: 1200mm Weight: 150kg

LOWER BODY

L010-R



Iso Lever Leg Curl

L: 1050mm W: 1400mm
H: 1600mm Weight: 140kg

LOWER BODY

L001-R



Iso Lever Leg Press

L: 1400mm W: 1600mm
H: 2500mm Weight: 180kg

LOWER BODY

U003



Olympic Incline Leg Press

L: 2500mm W: 1300mm H: 1400mm

LOWER BODY

U002



Olympic Hack Squat

L: 1400mm W: 1000mm H: 1400mm

LOWER BODY

SM

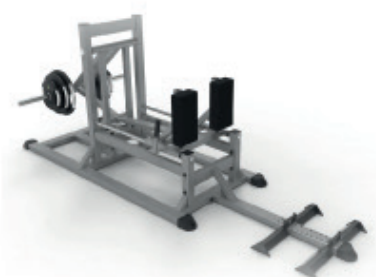

Scrum Machine

L: 3258mm W: 1300mm H: 1310mm

STATION STRENGTH

PLATE LOADED

LOWER BODY U230-R



Bi-Lateral Leg Press
L: 2640mm W: 1515mm H: 1590mm

This machine is designed for bilateral leg pressing, featuring a large base, a seat, and a backrest that can be adjusted to various angles. It has a central column with a weight stack and a footplate for the user's feet.

LOWER BODY L024-R



Donkey Kick
L: 1650mm W: 1100mm H: 1200mm

This machine is used for donkey kicks, featuring a seat, a backrest, and a footplate. It has a central column with a weight stack and a handle for the user's hands.

LOWER BODY L026-R



Belt Squat
L: 1905mm W: 1270mm H: 1675mm

This machine is used for belt squats, featuring a seat, a backrest, and a footplate. It has a central column with a weight stack and a handle for the user's hands.

LOWER BODY L027-R



Vertical Leg Curl
L: 1905mm W: 1270mm
H: 1675mm Weight: 250kg

This machine is used for vertical leg curls, featuring a seat, a backrest, and a footplate. It has a central column with a weight stack and a handle for the user's hands.

LOWER BODY L029-R



Recumbent Leg Press
L: 1905mm W: 1270mm
H: 1675mm Weight: 250kg

This machine is used for recumbent leg presses, featuring a seat, a backrest, and a footplate. It has a central column with a weight stack and a handle for the user's hands.

UPPER BODY U047



T-Bar Row
L: 2100mm W: 1250mm H: 700mm

This machine is used for T-bar rows, featuring a seat, a backrest, and a footplate. It has a central column with a weight stack and a handle for the user's hands.

UPPER BODY U043-R



Incline T-Bar
L: 1300mm W: 600mm
H: 1600mm

This machine is used for incline T-bar rows, featuring a seat, a backrest, and a footplate. It has a central column with a weight stack and a handle for the user's hands.

UPPER BODY L003-R



Iso Lever Shoulder Press
L: 1135mm W: 1255mm
H: 1250mm Weight: 160kg

This machine is used for iso lever shoulder presses, featuring a seat, a backrest, and a footplate. It has a central column with a weight stack and a handle for the user's hands.

UPPER BODY L004-R



Iso Lever Seated Row
L: 1100mm W: 1650mm
H: 1300mm Weight: 130kg

This machine is used for iso lever seated rows, featuring a seat, a backrest, and a footplate. It has a central column with a weight stack and a handle for the user's hands.

UPPER BODY L018



Iso Lever Flat Chest Press
L: 1800mm W: 1500mm
H: 1280mm

This machine is used for iso lever flat chest presses, featuring a seat, a backrest, and a footplate. It has a central column with a weight stack and a handle for the user's hands.

PLATE LOADED

UPPER BODY

L006-R



Iso Lever Lat Pull - Down

L: 1900mm W: 1200mm
H: 1800mm Weight: 130kg

UPPER BODY

L020



Iso Lever Incline Shoulder Press

L: 1430mm W: 1505mm
H: 1895mm

UPPER BODY

L021-R



Standing Shrug

L: 1905mm W: 1270mm
H: 1675mm Weight: 250kg

UPPER BODY

L002-R



Iso Lever Chest Press

L: 1400mm W: 1300mm
H: 1400mm Weight: 160kg

UPPER BODY

L007-R



Iso Lever Arm Curl

L: 2500mm W: 1300mm
H: 1400mm

UPPER BODY

L015



Iso Lever Floor Base Multipress

L: 1875mm W: 1855mm
H: 1685mm

UPPER BODY

L022-R



Side Lateral

L: 1100mm W: 1400mm
H: 1300mm

ALL BODY

U082-R



Smith Machine

L: 1300mm W: 2000mm
H: 2000mm

ALL BODY

U101-R



3D Smith Machine

L: 1444mm W: 1980mm
H: 2239mm

STATION STRENGTH

BENCHES

U087-R



Flat Bench

L: 1300mm W: 800mm
H: 650mm

U088-R



Utility Bench

L: 1200mm W: 450mm
H: 500mm Weight: 31kg

U028-R



Adjustable Decline Bench

L: 1905mm W: 1270mm
H: 1675mm Weight: 250kg

U099



Adjustable Incline / Decline Bench

L: 1300mm W: 800mm
H: 650mm

U500-R



Incline / Decline Bench

L: 1320mm W: 670mm
H: 450mm Weight: 29kg

U103-R



Adjustable Incline Bench

L: 1905mm W: 1270mm
H: 1675mm Weight: 250kg

U030-R



Military Press Bench

L: 1300mm W: 800mm
H: 650mm

U021-R



Olympic Bench Press

L: 1200mm W: 450mm
H: 500mm Weight: 31kg

BENCHES

U022-R



Adjustable Olympic Incline Bench

L: 1300mm W: 800mm H: 650mm

U023-R



Adjustable Olympic Decline Bench

L: 1200mm W: 450mm
H: 500mm Weight: 31kg

U029-R



Multipress 4 in 1 Bench

L: 1905mm W: 1270mm
H: 1675mm Weight: 250kg

U065-R



45° Roman Chair

L: 1300mm W: 800mm
H: 650mm

U045-R



Hyperextension

L: 1200mm W: 450mm
H: 500mm Weight: 31kg

U020-R



Reverse Hyper Bench

L: 1905mm W: 1270mm
H: 1675mm Weight: 250kg

U048-R



Glute / Ham Bench

L: 1300mm W: 800mm
H: 650mm

U242-R



Glute / Ham Bench

L: 1200mm W: 450mm
H: 500mm Weight: 31kg

U1007



Prone Row Bench

L: 1905mm W: 1270mm
H: 1675mm Weight: 250kg

STATION STRENGTH

BENCHES

U063-R



Preacher Curl

L: 1300mm W: 800mm H: 650mm

U501-R



Sissey Squat

L: 950mm W: 450mm
H: 575mm Weight: 35kg

U232-R

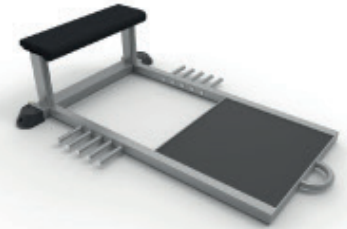

Hip Thruster

L: 1905mm W: 1270mm
H: 1675mm Weight: 250kg

U066-R



Crunch Curl

L: 1300mm W: 800mm
H: 650mm

U064-R



Adjustable Crunch Curl

L: 1200mm W: 450mm
H: 500mm Weight: 31kg

U234-R



Single Leg Squat / Nordic

L: 1300mm W: 800mm
H: 650mm

U234-RA



Single Leg Squat

L: 1200mm W: 450mm
H: 500mm Weight: 31kg

U239-R

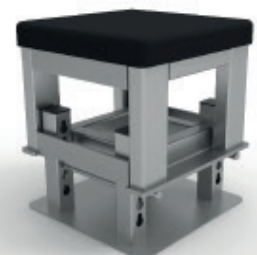

Squat Box

L: 1905mm W: 1270mm
H: 1675mm Weight: 250kg

BODYWEIGHT / MTP

U086-R



Dip Frame

L: 1300mm W: 800mm

U097-R



Leg Raise Chin Dip Frame

L: 1300mm W: 800mm
H: 650mm

U086A-R



Wall Mount Dip Frame

L: 1905mm W: 1270mm
H: 1675mm Weight: 250kg

U096-R



Chin / Dipping Frame

L: 1200mm W: 450mm
H: 500mm Weight: 31kg

U067-R



Dip / Leg Raise Frame

L: 1200mm W: 450mm
H: 500mm Weight: 31kg

U236-L



Mid Thigh Pull

U236-R



Mid Thigh Pull

OUTDOOR TRAINING

DEPLOYABLE AND
CONTAINER BASED
TRAINING SOLUTIONS



60237
OUTDOOR RIG



61596
20' WING



61595
20' STORAGE & FOLD OUT RACK



U205-R
DEPLOYABLE TRAINING POD



TBR20
20" TACTICAL RIG

60237
BOX ROPE CLIMB

61571
BOX SQUAT STATION

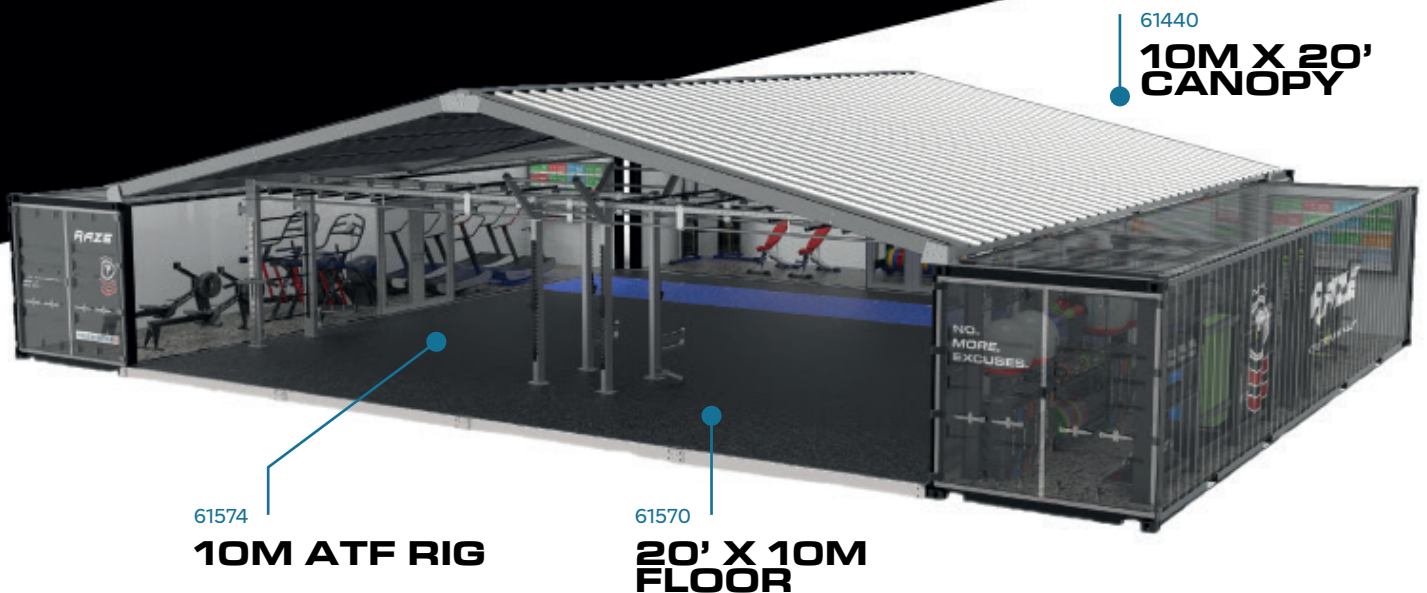
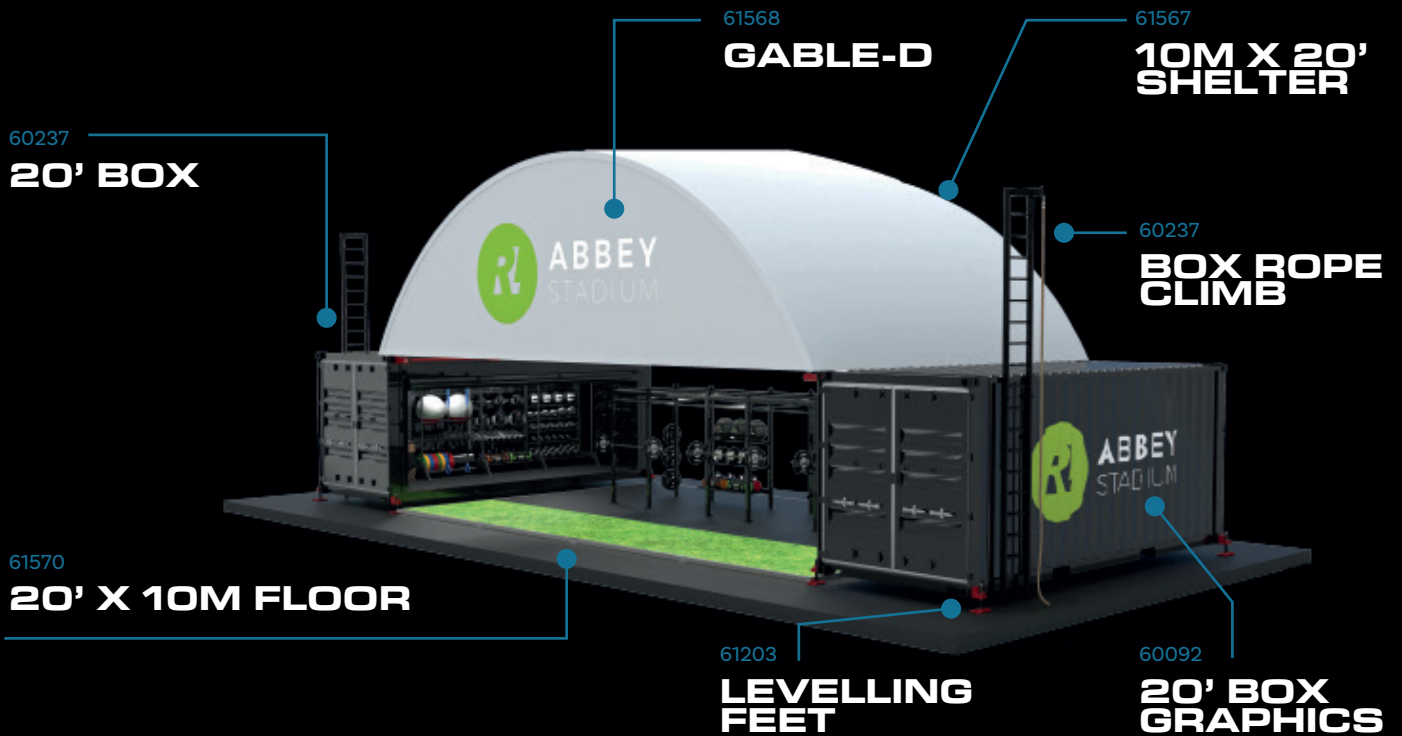

**FOR MORE INFORMATION ON OUR DEPLOYABLE AND CONTAINER
BASED TRAINING SOLUTIONS, PLEASE GET IN TOUCH...**

01455 890 100 OR INDIGOFITNESS.COM AND ASK FOR A BROCHURE

kenguru pro

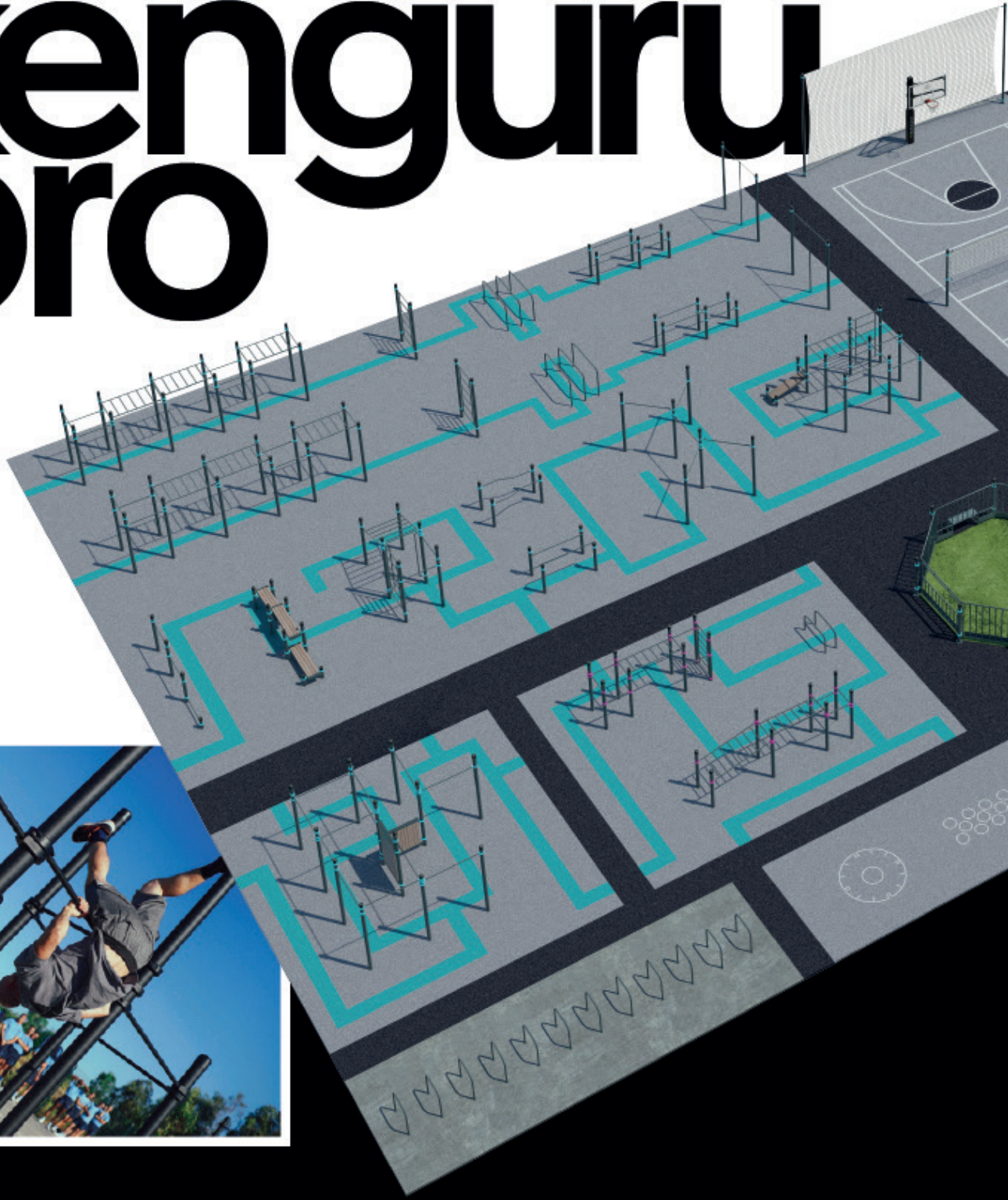

changing the way
to exercise outdoors...

intergenerational inclusive & fun



- street workout
- calisthenics
- parkour
- chase-tag
- para workout
- kids
- pro-wall

UPTIVO

LIVE 

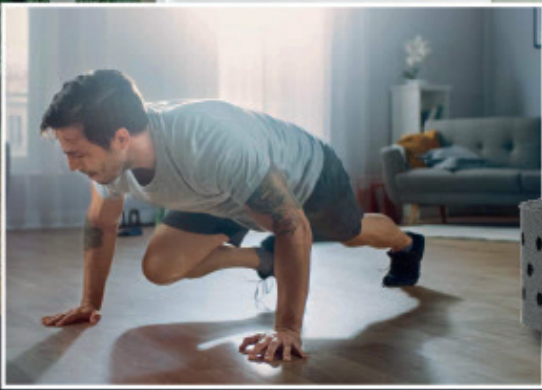
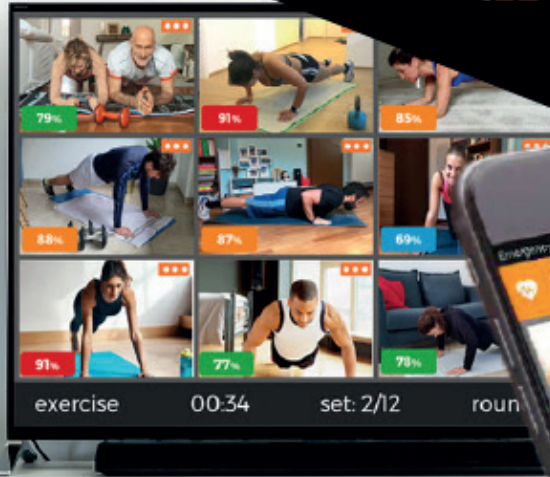

Online training made real.

Remote training with real-time heart rate telemetry. 

Uptivo LIVE is designed to offer a safe, engaging, and motivating live fitness experience providing a real-time, bi-directional flow of performance data between trainer and athletes.

At the club, from home. 

Uptivo LIVE allows to create remote training sessions with up to 50 participants or one-to-one, providing a customized and personalized service. Trainers can monitor each athlete's heart rate frequency in real time in order to adjust the session intensity and rhythm, just as a lesson at the Club.

- Audio/video chat
- HR activity data
- Circuit timers
- Workouts
- Training zones
- UPPs and calories
- Athlete → Trainer telemetry
- Athlete ↔ Athlete telemetry



A professional service, directly on your phone

Uptivo LIVE is integrated in your members' Uptivo app to provide an easy and quick access to the system at no additional cost. Trainers and members also have a Windows application at their disposal to visualize and interact with up to 25 athletes simultaneously.



At the right pace.

Unlike typical online meeting apps, Uptivo LIVE features a dedicated media channel that allows trainers to stream crystal clear music and sound directly from their device.

- Dedicated media channel
- Sound and music synchronization



Trainer journal.

Regardless of where the training is performed - at the Club or at home -coaches have all the necessary information at their disposal to motivate trainees, provide feedback, & introduce new activities in order to reach members' individual training targets.

- Training history and report
- Trainer feedback
- Advanced biometrics



With your Club in mind.

Uptivo puts your Club in the foreground in all communications, activities and contents related to the cardio monitoring platform,with the goal to differentiate yourself from your competitors.

- Email invites to new members
- Posts on social media
- Workout summary emails
- Marketing materials



Increase members' motivation and retention, even remotely.

Uptivo makes online sessions really engaging and motivating, thanks to gamification and by encouraging friendly competition among athletes.

- Rankings
- Levels
- UPPs



Uptivo Performance Points (UPPs).

UPPs allow to evaluate Club members' effort regardless of individual age, gender and physical shape. The higher the effort, the more points are rewarded! Designed to combine motivation and effort with safety and self awareness, the UPPs system rewards intensive exercise, but not overtraining.



Keep in touch with your customers.

Share your workout tutorials,promote a new offer or give a special welcome to a new member directly on their phone via the Uptivo app.

- Message templates
- YouTube videos
- Link and images
- Notifications



The choice is yours.

At the core of LIVE sessions, Uptivo Belt-D and Uptivo Armband provide accurate heart rate monitoring and long-range transmission to your members.

- Bluetooth Smart
- ANT+
- Long Battery Life

FLOORING

Flooring is the foundation of your facility; it literally underpins everything you will do in your gym, but it's an area that's often overlooked.

When designing a training space, we always approach it from the ground up, floor first. Getting your gym flooring right will set the tone for the rest of your space and allow you to build a safe and effective environment. And we really do believe it's the most critical element to get right first time. Mistakes with flooring can be costly, complicated, and time consuming to correct once your gym is open and operational.

To help you select the most appropriate flooring types and installation methods we offer professional site surveys and installation services. We work with some of the best brands and products in the industry that between them offer a broad and balanced portfolio of products and solutions, catering for every flooring need.

CONTENTS

ENDURA	71
INSET PLATFORMS	71
DURATRAIN	72
DURASOUND	73
PAVI	74

ENDURA floor

PavFLEX
GYM FLOORING

duraTRAIN
RUBBER FITNESS TILES

duraSOUND
RUBBER ACOUSTIC TILES

ENDURA / INSET PLATFORMS



Black / Red - 60462
Black / Blue - 60463
Black / Grey - 60464
Black / Green - 60465
Black / Yellow - 60466

EnduraRoll 10mm

10m x 1.25m

Black - 61085



EnduraTile 30mm

L: 100mm W: 100mm

61289



Joining Plate

L: 100mm W: 100mm

Black - 60960

Black / White Fleck - 60761



EnduraTile 30mm

L: 50mm W: 50mm

60816



EnduraSport

Available in 9 colours



Birch 20mm - 61415
Birch 32mm - 61090
Oak 32mm - 61325
Oak 51mm - 61326

Platform Logos Available

Inset Platforms

2.4m x 0.98m

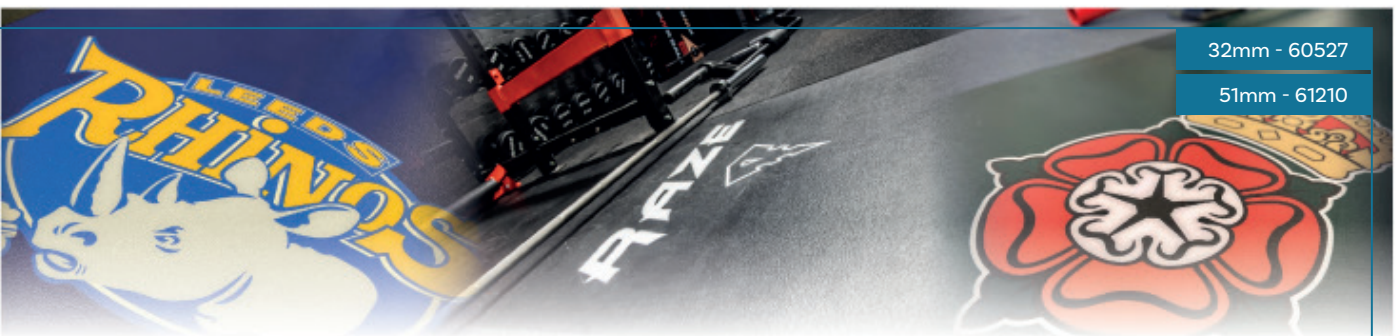

32mm - 60527
51mm - 61210

Graphix Inset Platforms

2.4m x 0.98m

DURATRAIN

ENGINEERED FOR PERSONAL BESTS



26dB
Sound Reduction
(thats 4x quieter!)



- Available as 32mm tile
- High Performance Fitness Flooring
- Superior Sound attenuation & shock insulation
- Tight seam lines provide superior aesthetics
- Tested for over 400,000 repeated impacts with a 360kg blunt force
- Maintenance free

DuraSound and DuraTrain are available in the following colours and finishes

PLUS+

DuraTrain PLUS range offers a wide range of solid colour options at an economical price.

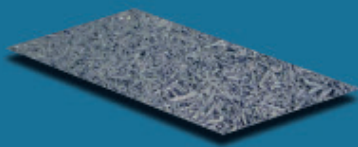

- 100% recycled rubber
- Porous wear layer
- Fire classification Efl

PREMIUM

Made from 100% recycled SBR rubber backing and topped with an EPDM wear layer, our Premium Line allows more colour blends and the ability to truly customize your floor with floor graphics and full colour logo application abilities.

10 RANGE

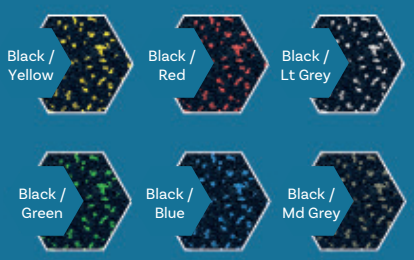

IMPROVE THE EXPERIENCE. REDUCE THE SOUND

Available as 51 and 70mm tile



Dramatically reduce the disruptive noise and vibrations of fitness equipment with DuraSOUND rubber acoustic fitness tiles.

Designed to dissipate energy for a better acoustical experience for both you and your neighbouring businesses. DuraSOUND rubber acoustic fitness tiles are performance engineered to control vibrations, minimise low-frequency impact noise, and reduce the transmission of sound by up to 38 decibels (dB)

PREMIUM COLOURS CONTINUED...

**35
RANGE**



**70
RANGE**



**90
RANGE**

TRI
COLOUR



QUAD
COLOUR

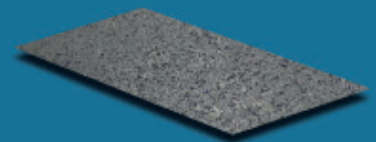

- Prefabricated EPDM wear layer
- Easy to clean & hygienic
- Many colour options
- Fire classification Cfl

BRING SOME FUN TO YOUR FLOOR

With **PaviFLEX**
GYM FLOORING

The best floor for each activity, so comfortable that anyone could train barefoot on it. Produced in Spain with a high density powerful non-marking virgin rubber, PaviFLEX flooring is so elastic that will return the energy of the impact and will reduce the risk of injuries when training. It is made for intensive use so it is resistant and durable as no other in the market, it absorbs the impacts acting as an excellent acoustic isolation material, with the optimum friction coefficient for each sport activity. It is water proof, very easy to clean and maintain, and the installation is really easy, just puzzle interlock the tiles on a clean and plain surface, you do not need to glue. PaviFLEX is fully customizable in colours, finishings and markings with insertions so they will never go away.



A

Action

Thickness: 11.5mm Dimensions: 100x100cm



A

Tatami Pro

Thickness: 20mm & 30mm, Dimensions: A - 100x100cm



A

Yoga

Thickness: 5mm, Dimensions: A - 100x100cm



A

Stretching

Thickness: 20mm, Dimensions: A - 100x100cm

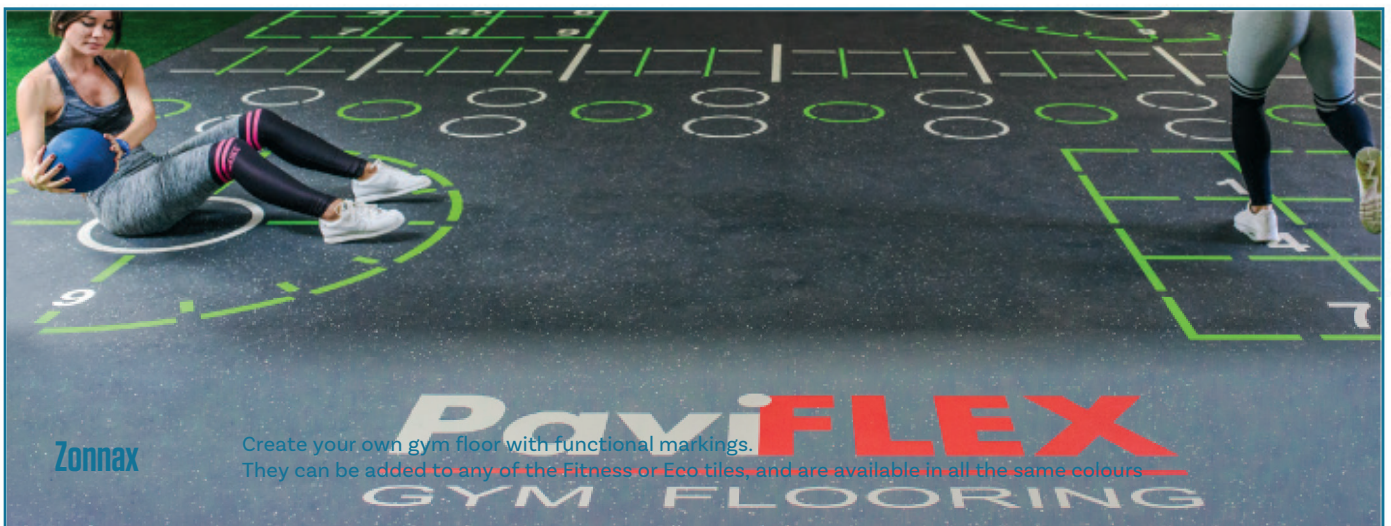

PAVI

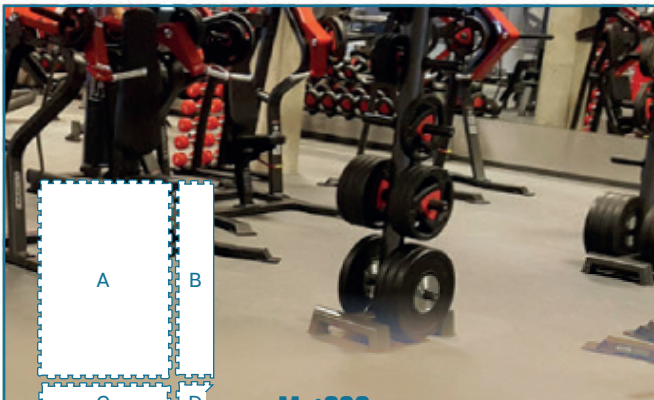

Mat030

Dimensions: A - 188x105cm, B - 188x30cm, C - 105x30cm
D - 30x30cm, Thickness: 30mm

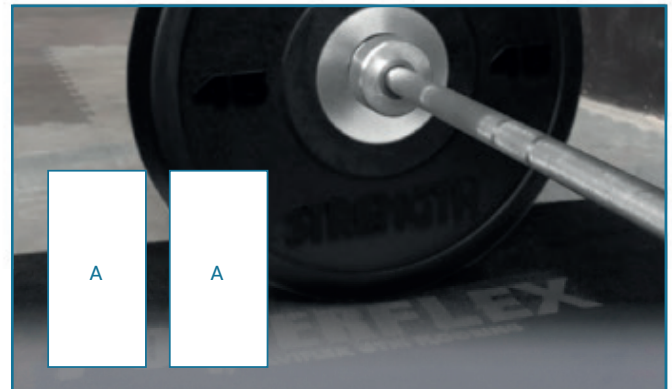

Power Flex - Portable Lifting Mats

Dimensions: 90x45cm
Thickness: 30mm



Comfort Sonic Underlay

Dimensions: 190x100cm
Thickness: 10mm



9mm Mats

- Small: 20x50mm
- Medium: 140x60mm
- Large: 160x60mm
- XLarge: 80x60mm

19mm Mats

- Small: 20x50mm
- Medium: 140x60mm
- Large: 160x60mm
- XLarge: 80x60mm



Turfex

Excellence - 12mm Thick
Premium - 16mm Thick

Available in 4 colours. Can be inlaid with your logo and functional markings



Specialist Advice

As well as advising on types and styles of gym flooring, we are also able to offer guidance and support on wider flooring subjects such as acoustics, sub-floor construction, preparation, screed and levelling compound types, and alternative methods to prepare or stabilise floors. We're happy to be brought in during the very early planning stages of a project, working with you and your construction partners, to ensure you get the correct solution.



Quality Results

To help with final decisions we'll send you flooring samples, so you can check textures and colours to make sure everything looks and feels just right. Then, when it's time for the installation, you can rest assured your flooring will be fitted to a high standard by professional, qualified, and experienced installers, guaranteeing a high standard of fitting and a quality result.



Work with us

And you'll benefit from our expertise and technical know-how, gained from years of creating and installing fitness flooring solutions.

DREAMING OF A NEW GYM?

But wondering how to finance it?
Whether you are looking for a small
PT studio, or a brand-new gym,
we can help make your money go further.

- ✓ Finance from 5K
- ✓ Slow start finance
- ✓ Repayment period 1-5 years
- ✓ Fast decision
- ✓ New business finance

You might think that brand new equipment is costly, but it doesn't have to be! Equipment leasing a fantastic way of getting finance on terms which are far more favourable than traditional bank lending.

Whether you are an established gym or leisure facility, a new starter, or a personal trainer, we can help provide the gym equipment you need. Incredibly flexible, we finance everything from a single treadmill to a whole room of bikes. Keep ahead of the competition by leasing the very latest equipment.



Terms and Conditions:
Finance provided via Johnson Reed Ltd; Doc fee's apply
Limited companies only. E&OE. FCA: 66188

SUPPORT

Along with offering industry leading warranties on our UK manufactured products, we're also there for you with technical support and service contracts, ensuring your equipment is kept in optimal condition so you can keep your facility running.

Support Team

If your equipment develops a fault, you can call our customer support team. They will take the relevant information from you and discuss with our engineers to diagnose the problem and find the solution, sending out one of our field service engineers if necessary.



Service Contracts

Preventative maintenance and regular servicing are key to prolonging the life of your equipment and minimising down-time. As such, we offer a range of service contracts to fit your needs.

You can contact our support team on 01455 890 100,
or via email on support@indigofitness.com

RAZE



INDIGOFITNESS



12 Rue Saint Olive
38500 VOIRON
T2L 04 76 91 82 66
01455 890100
info@bodytoniform.com



www.bodytoniform.com

