

BODY TONIC FORM

TRENDY SPORT®

2

3



BUREBA®



BAMUSTA®



>>
PLEASE CLICK DIRECTLY
TO THE PRODUCT!



BALANCE PRODUCTS



FITNESS & REHA



PROFIGYMMATS®



FASCIA PRODUCTS



CORK LINIE



PROFIGYMMAT



PILATES

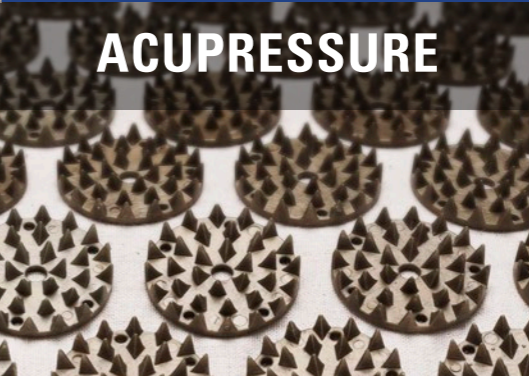

ACUPRESSURE

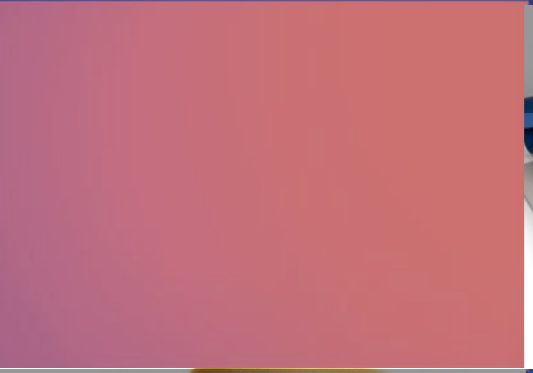

YOGA

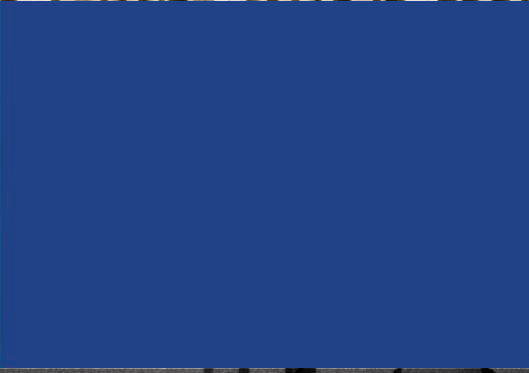

ACCESS CONTROL



LOOPS & TUBES



ATS LINE



ATS®



FLOORING MATS

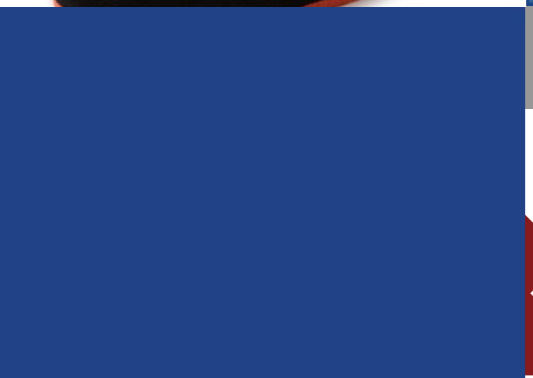

WEIGHTS

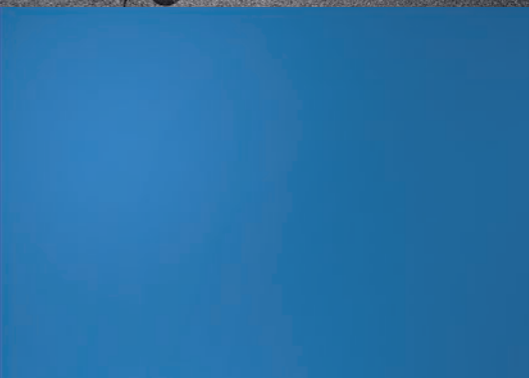
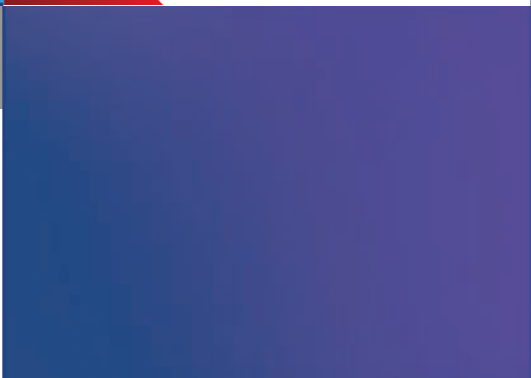

PROFIGYMMATS®

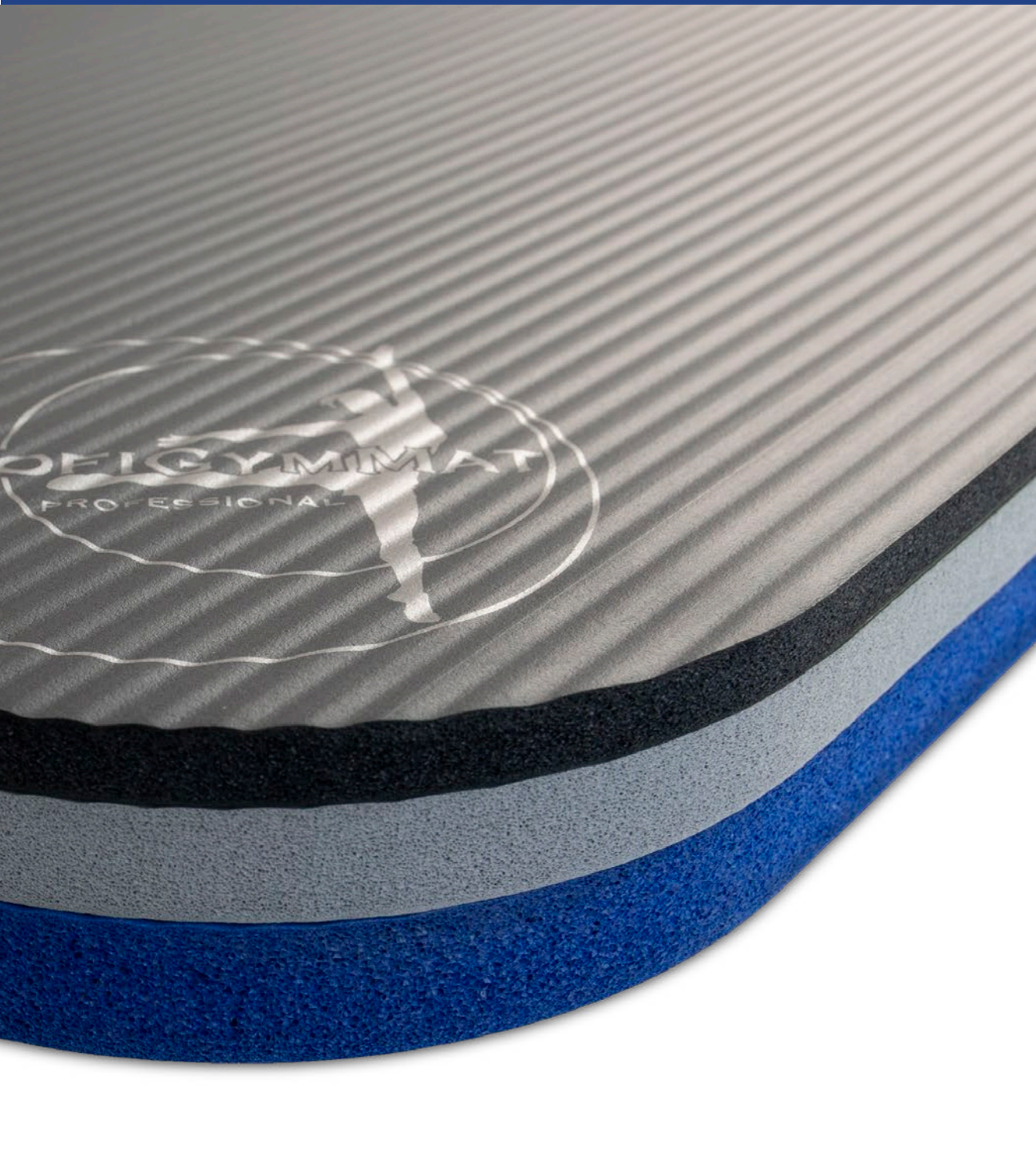

PROFIGYMMAT®



THERAMAT



REHAMAT



ACCESSORIES

ProfiGymMat



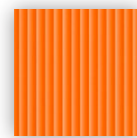
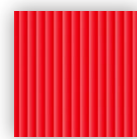
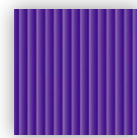
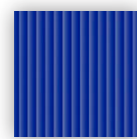
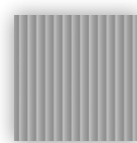

110 Kg/m³

ProfiGymMat®

180 x 60 cm, 110 Kg/m³
Material: NBR

Like all of our ProfiGymMats, this gym mat consists of the soft and stable NBR foam. With a density of 110 Kg/m³, this ProfiGymMat is the softer version and is used particularly in the private sector. The food-safe material is characterized by its mechanical resistance and is therefore extremely durable. The mat is BPA-free and therefore suitable for pregnancy exercises and fitness with children.

Colour/Thickness	1 cm	1,5 cm
Grey	8204GR	8205GR
Anthracite	8204A	8205A
Blue	8204B	8205B
Purple	8204P	8205P
Red	8204R	8205R
Orange	8204OR	8205OR



- resilient
- tear-resistant
- dimensionally stable
- easy adaptation
- comfortable and flexible
- antibacterial protection
- easy to clean with water

▶ MORE DETAILS

▶ INDIVIDUALIZATION

ProfiGymMat® with eyelet

180 x 60 cm, 110 Kg/m³
Material: NBR

The ProfiGymMat® is also available with eyelets in the same quality but with a limited colour selection.

Colour/Thickness	1 cm	1,5 cm
Grey	8124GR	8125GR
Anthracite	8124A	8125A
Blue	8124B	8125B

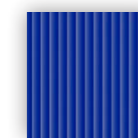
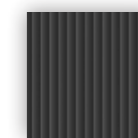
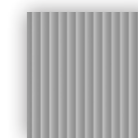

closed cell structure



antibacterial protection



optimal absorption



customizable



durable



harmless

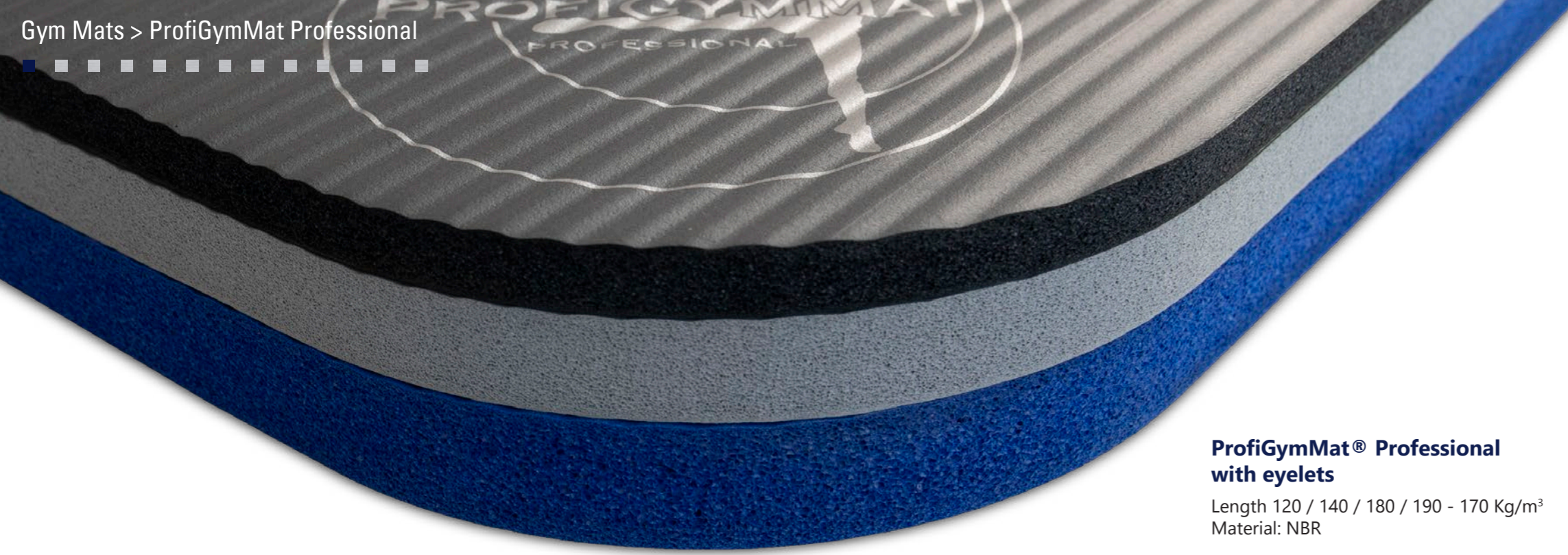

Did you know?

ProfiGymMat's are free of:

- BPA
- Formamid
- Latex
- Toxic Plastic

ProfiGymMat® Professional with eyelets

Length 120 / 140 / 180 / 190 - 170 Kg/m³
Material: NBR

The ProfiGymMat® Professional is also available with our owned designed high quality eyelets.

- resistant and stable in shape
- tensile strength
- comfortable, flexible and flat lying
- easy rolling and unrolling
- no sticking-out corners
- optimum shock absorbing
- both sides usable, in the studio, outdoor and in water
- super hygienic
- closed cellular structure
- anti-germ protection
- hydrophobic and dirt-repellent
- easily cleanable with water

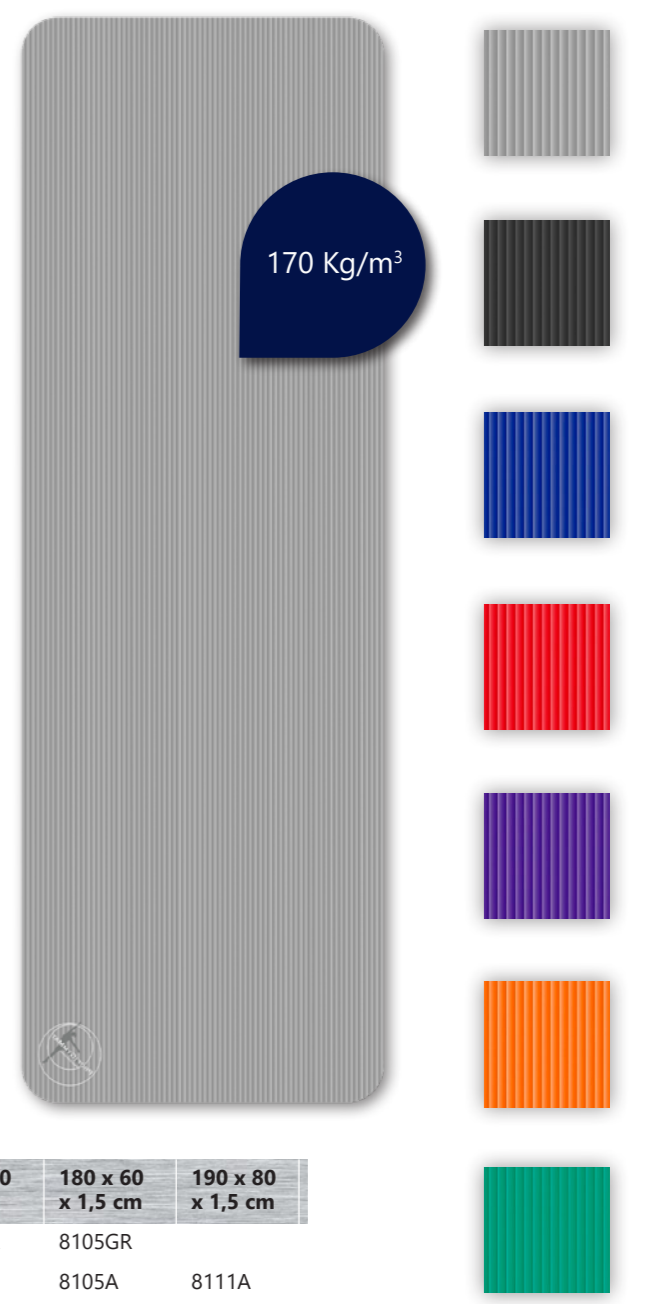

▶ MORE DETAILS

ProfiGymMat® Professional

Length 120 / 140 / 180 / 190 - 170 Kg/m³
Material: NBR



The ProfiGymMat® Professional is extremely robust with a material density of 170 kg/m³. Due to the new vertical structure, the mat wears less. This makes them even more comfortable and increases their durability at the same time.

The mat is BPA-free and therefore suitable for pregnancy exercises and fitness with children. The quality of the new generation of ProfiGymMat® Professional speaks for itself and meets the highest demands in all professional areas.

Colour/Size	120 x 60 x 1 cm	140 x 60 x 1 cm	140 x 60 x 1,5 cm	180 x 60 x 1 cm	180 x 60 x 1,5 cm	180 x 60 x 2 cm	190 x 80 x 1,5 cm
Grey	8016GR	8001GR		8004GR	8005GR		
Anthracite	8016A	8001A	8002A	8004A	8005A		8011A
Blue	8016B	8001B	8002B	8004B	8005B	8006B	8011B
Red	8016R	8001R	8002R	8004R	8005R	8006R	8011R
Purple		8001P		8004P	8005P		
Orange		8001OR		8004OR	8005OR		
Green		8001G	8002G	8004G	8005G	8006G	

Colour/Size	120 x 60 x 1 cm	140 x 60 x 1 cm	140 x 60 x 1,5 cm	180 x 60 x 1 cm	180 x 60 x 1,5 cm	190 x 80 x 1,5 cm
Grey	8116GR	8101GR		8104GR	8105GR	
Anthracite	8116A	8101A	8102A	8104A	8105A	8111A
Blue	8116B	8101B	8102B	8104B	8105B	8111B
Red	8116R	8101R	8102R	8104R	8105R	8111R
Purple		8101P		8104P	8105P	
Orange		8101OR		8104OR	8105OR	
Green		8101G	8102G	8104G	8105G	









TheraMat Professional

180 x 120 x 1,5 cm
Material: NBR

optional
with eyelets
available

-  closed cell structure
-  antibacterial protection
-  optimal absorption
-  durable
-  BPA FREE harmless

The luxury variant of the ProfiGymMat is called TheraMat Professional. In addition to the therapy, the rehabilitation area is also an area of application. The TheraMat impresses by its size: 180 cm x 120 cm in thicknesses 1,5 cm. With this measurements it is indispensable in the therapeutic field. Self-exercises lateral roll movements are no problem. Of course the TheraMat has all the advantages of the ProfiGymMat®. Also available including eyelets.



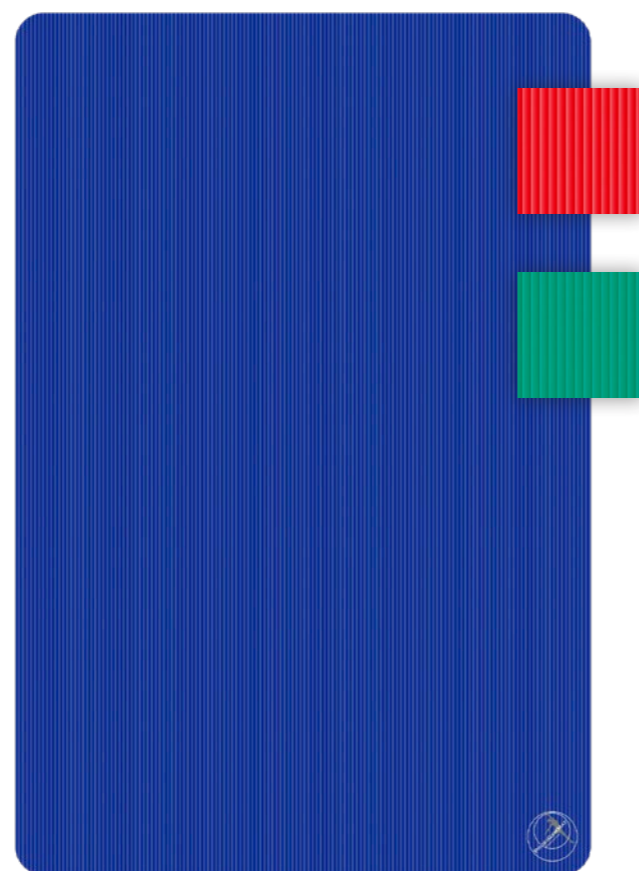

▶ MORE DETAILS

Colour/size	without eyelet	with eyelet
Blue	8007B	8107B
Red	8007R	8107R
Green	8007G	8107G



RehaMat Professional

200 x 100 x 2,5 cm
Material: NBR

-  closed cell structure
-  antibacterial protection
-  optimal absorption
-  durable
-  BPA FREE harmless

The new RehaMat Professional is matched to the highest demands in the rehabilitation sector. Due to its shape with straight edges, it is perfectly suited for assembling several mats for group therapy. With a thickness of 2,5 cm the RehaMat Professional provides the right foundation for demanding exercises.

Of course the RehaMat Professional has all the advantages of the ProfiGymMat® Professional.

▶ MORE DETAILS

Colour	Article
Anthracite	8009A
Red	8009R
Blue	8009B

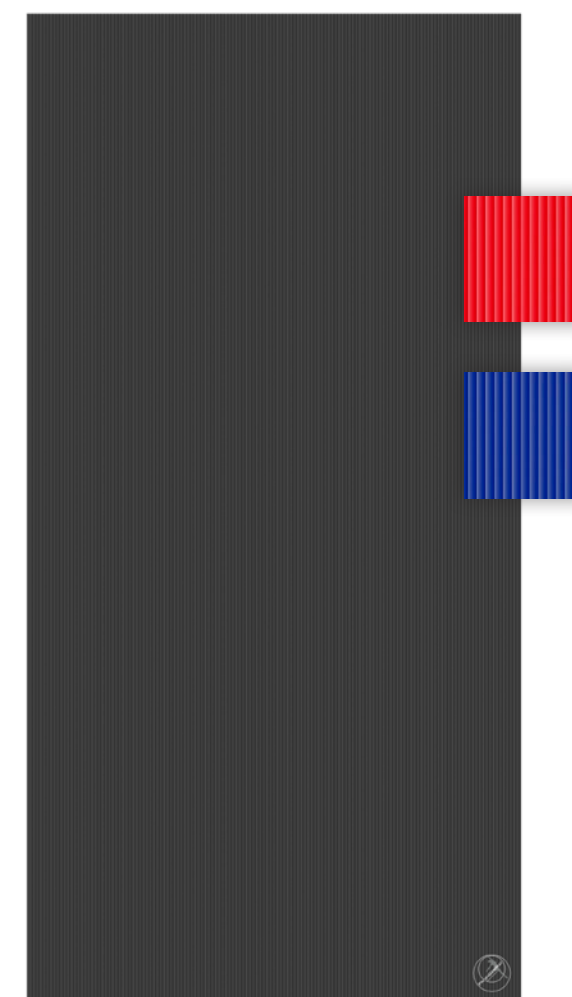



▶ MORE DETAILS

Mount metal

85 x 8 cm
 Eyelet distance variable, max. 68 cm
 Material: Steel, coated

Our variable mount metal is an individually adjustable wall suspension for all kind of mats with max. eyelet distance of 68 cm.

The product is now available in silver or anthracite.

max. capacity

- ProfiGymMat 1 cm: 15 pcs.
- ProfiGymmat 1,5 cm: 10 pcs.
- Trendy YogaMat 0,5 cm: 20 pcs

new colour!

Article	8108
Anthracite	8108
Silver Grey	8108SG



▶ MORE DETAILS

Mat cart

78 x 52 x 206 cm
 Eyelet distance variable
 Material: Aluminium

Our mat trolley made of lightweight aluminium is suitable for our gymnastics mats with a maximal length of 190 cm and an eyelet system. It is very flexible and mobile thanks to the roller system and the variable eyelet distance.

ProfiGymMat 1 cm: 30 pcs.
 ProfiGymmat 1,5 cm: 20 pcs.
 Trendy YogaMat 0,5 cm: 60 pcs.

Article	8106
---------	------



Carry Bag

Length 180 cm
 Material: PU

The carrying bag for ProfiGym-mats® size 120 - 140 - 180 not only guarantees you space-saving and protected storage, but also makes the mat comfortable to carry. In addition, the mat on the side wall of the bag is easier to remove.

▶ MORE DETAILS

Article	8110
---------	------



ProfiGymMat® Seat Cushion

35 x 30 x 1,5 cm
Material: NBR

The ProfiGymMat® seat cushion is based on the NBR material from the ProfiGymMat® Professional and can be used in many ways. The handle recess allows a comfortable transport, so that the seat cushion can also be ideally used on the go. The surface is also easy to clean.

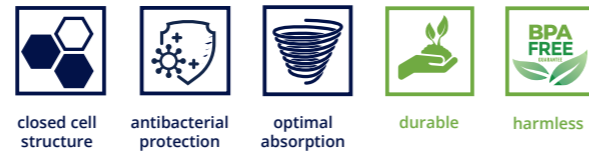

Colour	Article
Anthracite	9030A
Red	9030R
Blue	9030B

[▶ MORE DETAILS](#)

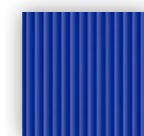

[▶ MORE DETAILS](#)

Velcro Profi

Material: PP

With the help of the velcro tape, you can now hold your ProfiGymMat® particularly easily together. In addition, the connection between the two velcro straps guarantees easy transport.

[▶ MORE DETAILS](#)

Velcro Standard

Material: PP

With the help of the velcro tape, you can now hold your ProfiGymMat® particularly easily and therefore also transport it. They have a length of 78 cm.



Article	8013
---------	------

Article	8014
---------	------

BALANCE PRODUCTS



TRENDY MEIA



ACCESSORIES



GYMNASTIC BALL



BUREBA®

BALANCE CUSHION



BALL COVER



BALANCE CUSHION COVER



BALANCE BOARDS



BAMUSTA®

BALANCE PADS





Antislip surface

► MORE DETAILS

Trendy Meia®

Size: Ø 60 x max. 22 cm
Material: PVC, PP

The new Trendy Meia® is a versatile training device. It enables exercises for balance, dexterity and strengthening of the muscles. Make use of the top and bottom!

The Trendy Meia® is an ideal combination of Bureba® Ball and Barmusta® Board.

The Trendy Meia offers a non-slip and safe base for all applications. The scope of delivery includes an inflation pump and a tape measure.

Max carrying capacity 200 KG
Incl. new sales packaging.

Colour	Article
Anthracite	9600A
Black/Blue	9600B
Black/Grey	9600GR

Incl. pump



New
soon available

Trendy Meia® Expander

Length: 1 m
Material: TPR, Nylon cover

With our new Trendy Meia® Expander you can add a useful addition to your Trendy Meia®. The expanders only have to be hooked into the rings provided on the side of the Trendy Meia using the high-quality stainless steel carabiner. This gives you even more exercise options for balance, strength and coordination with your Trendy Meia®.

Article	9611
---------	------





BURST RESISTANT BALL

Bureba® Ball Professional

Material: PVC 6P free

The Bureba® Ball Professional can be used both as a training device and as a sitting ball. The exercise ball is particularly suitable for strengthening the upper body and core muscles and also improves posture and balance. With different exercises in standing, sitting, lying down or on your back, the different muscle groups can be addressed and the intensification of the training adjusted.

The exercise ball meets extremely high safety requirements. The carrying capacity is 300 kg and thanks to the burst system, the ball cannot burst even if it is damaged with sharp objects.

The Bureba® Professional is available in three sizes and four colours as well as transparent and can be inflated and regulated individually with each pump.

Max. carrying capacity 300 kg
Burst resistant up to 100 kg
Incl. sales packaging
Including pump

[▶ MORE DETAILS](#)

now
transparent
available



Colour/Size	Ø 55	Ø 65	Ø 75
Transparent	7030T	7040T	7050T
Anthracite	7030A	7040A	7050A
Blue	7030B	7040B	7050B
Red	7030R	7040R	7050R
Grey	7030SG	7040SG	7050SG



antibacterial
protection



durable



recyclable



6P
FREE





Bureba® Ball

Material: PVC 6P free

The Ø 65 cm Bureba ball was specially developed for home training. The printed exercises provide the user with exercise examples. The Bureba® ball is burst-proof and available in five different colours.



► MORE DETAILS

Max. carrying capacity 200 kg
Incl new sales packaging
Including pump

Colour	Article
Anthracite	7240A
Blue	7240B
Purple	7240P
Red	7240R
Orange	7240OR



incl.
pump





▶ MORE DETAILS

Hand pump

With this hand pump you can easily inflate each of our seat balls. Thanks to the double stroke function, the ball can now be inflated even faster.



Article 6021

▶ MORE DETAILS



Ball bowl

Ø 45 cm

Thanks to the ball cup, your sitting ball stays in the desired position and cannot roll away. The ball cup is suitable for all seating ball sizes.

Article 6022

▶ MORE DETAILS

Bureba® Stacking system

Size: 10 cm / Ø 31 cm
Material: PMMA



With the Bureba stacking system, several Bureba® balls can be stacked on top of each other to save space.

Article 6024



▶ MORE DETAILS

Bureba® Rack

For 10 Bureba® 55 cm
Hight 195 cm / Ø 100 cm
Material: Steel, coated

Article 6023



Bureba® Ball cover

Size: ca. Ø 65 cm



Complement your Bureba exercise ball with our soft and neutral grey-brown fabric cover. This can be easily attached with a zipper and can be removed at any time and washed hygienically at 30°. A handle makes it easier to hold and transport the ball and a rubber ring on the underside of the cover ensu-

res that the ball cannot roll away. The exercise ball is transformed into beautiful furniture and offers even more comfort for your home office, physiotherapy, fitness or yoga studio.

Prices will follow soon.

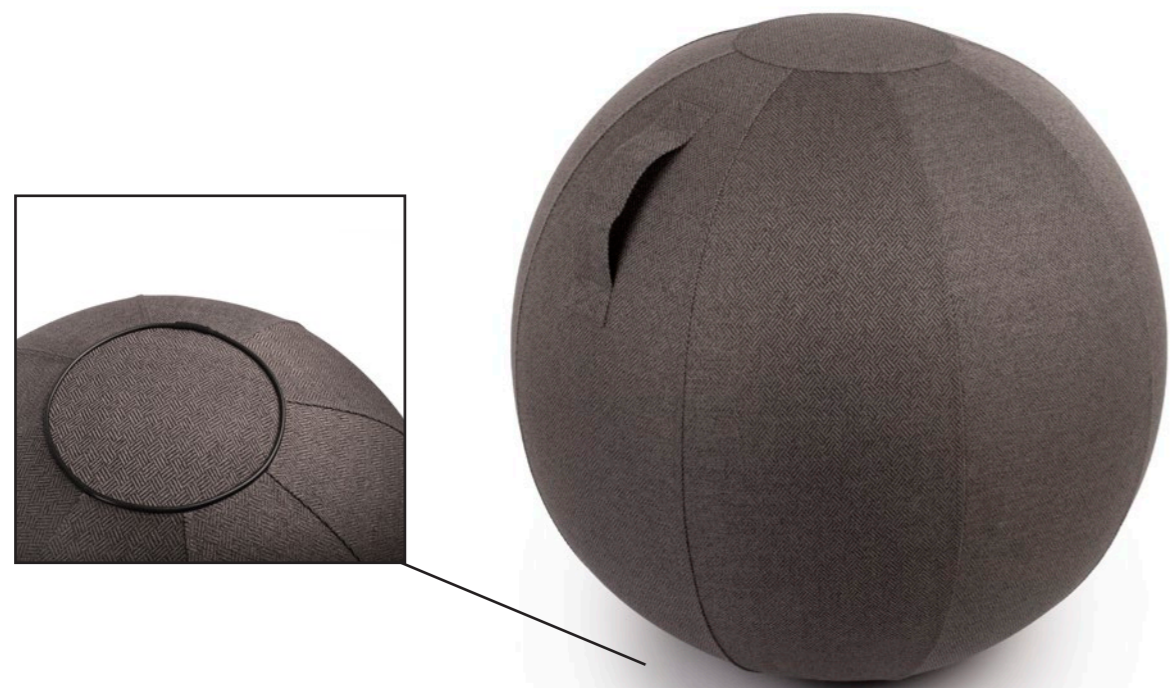

Bamusta® Coxim cover

Size: ca. Ø 33 cm

The Bamusta Coxim cover is a practical accessory for our Bamusta Coxim seat cushion and fits both the version with and without nubs. The cover can be opened via the zipper and easily pulled on. The cover can also be washed at 30° and is therefore particularly hygienic.

Prices will follow soon.





incl.
pump



Bamusta® Coxim

Ø 33 cm
Material: PVC 6P free

► MORE DETAILS

With its air cushion, the Bamusta® Coxim very comfortably transmits all movements. The special feature here is the air regulation by means of a needle valve thus the air level in the pillow can be adjusted individually. The seat cushion consists of two smooth sides.

This product not only trains the back muscles and promotes an

upright sitting position, but also achieves a new form of sitting. Of course, the Bamusta® Coxim can also be integrated into a training session in order to achieve more body tension and balance.

Max. carrying capacity 300 kg
Incl. sales packaging
Pump included

Colour	Article
Anthracite	9191A
Blue	9191B
Red	9191R
Grey	9191GR



antibacterial protection



durable



recyclable



6P FREE

► MORE DETAILS

Bamusta® Coxim with knops

Ø 33 cm
Material: PVC 6P free

The seat cushion is also available with a smooth and a nubby side. The decision whether to sit on the smooth or nubby side of the seat cushion is also up to the user and offers an even wider range of training options.

Max. carrying capacity 300 kg
Incl. sales packaging
Pump included

Colour	Article
Anthracite	9190A
Blue	9190B
Red	9190R
Grey	9190GR



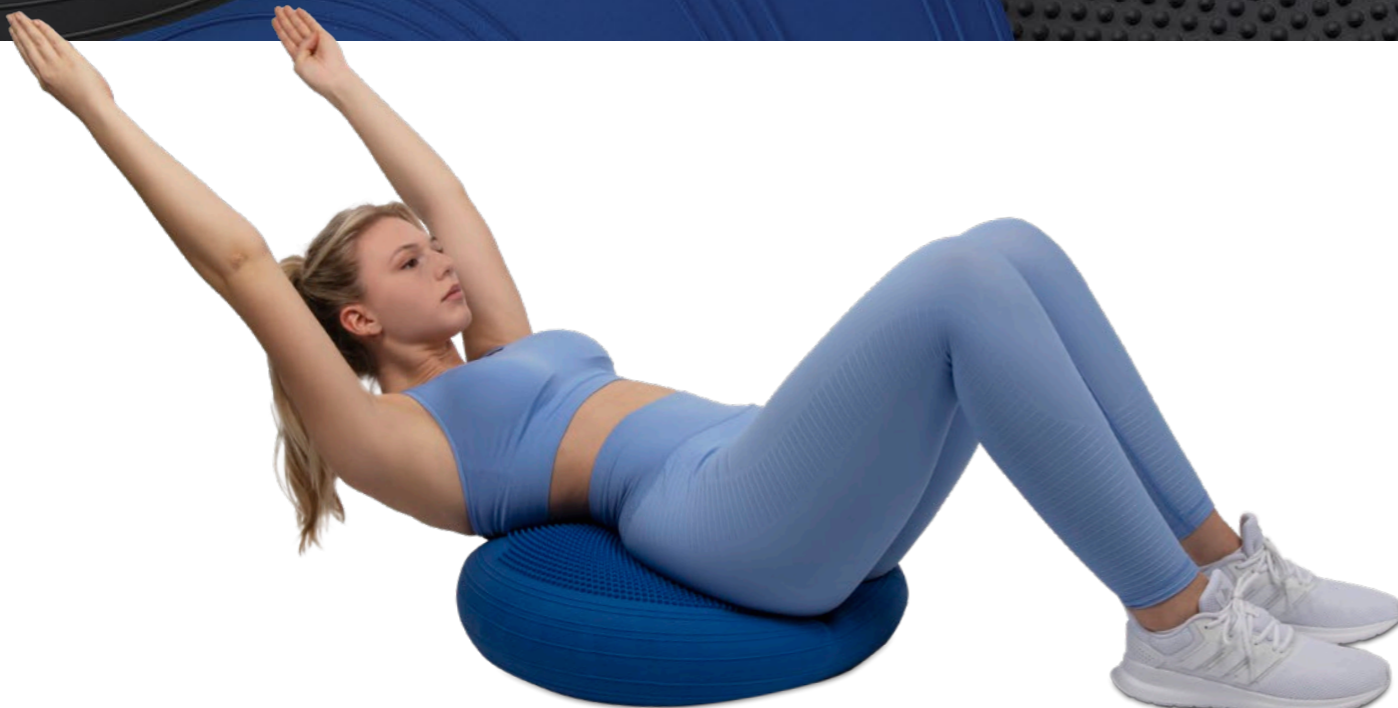

▶ MORE DETAILS

Bamusta® Coxim XXL with knops



Ø 60 cm
Material: PVC 6P free

With its air cushion, the new 60 cm Bamusta® Coxim XXL very comfortably transmits all movements. The special thing here is the air regulation by means of a needle valve, so that you can adjust the air level in the pillow as you like. This product with a smooth and a nubby side not only trains the back muscles and promotes an upright sitting posture, but also achieves

a new form of sitting and balance. Of course, the Bamusta® Coxim XXL can also be integrated into a training session in order to achieve more body tension and balance.

Max. carrying capacity 300 kg
Incl. sales packaging
Pump included



-  antibacterial protection
-  durable
-  recyclable
-  6P FREE

Colour	Article
Anthracite	9094A
Blue	9094B
Grey	9094GR

incl. pump



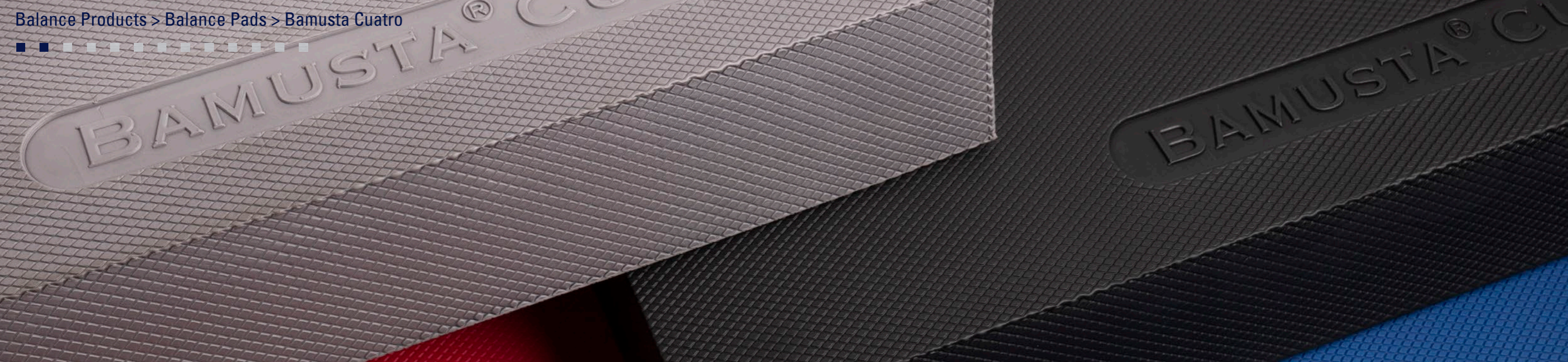

► MORE DETAILS

Bamusta® Cuatro XL

48 x 48 x 6 cm
Material: TPE

- 
closed cell structure
- 
antibacterial protection
- 
optimal absorption
- 
light weight
- 
allergy friendly
- 
100% recyclable
- 
free of softener

The square Bamusta® Cuatro XL is made of 60 mm thick closed-cell foam and impresses with its excellent damping properties, even with punctual loads, is also non-slip due to the waffle structure, water-repellent and easy to clean. The 100% recyclable material is free of PVC and plasticizers and therefore particularly skin-friendly.

As soon as the user steps on the Bamusta® Cuatro XL, he automatically begins with the balance training. Its weight creates compression, which immediately demands coordination and balance of the user.

Max. carrying capacity 300 kg
Incl. sales packaging.



Colour	Article
Anthracite	9000AXL
Blue	9000BXL



antislip surface



Picata Acupressure cover
Matching accessory



► MORE DETAILS

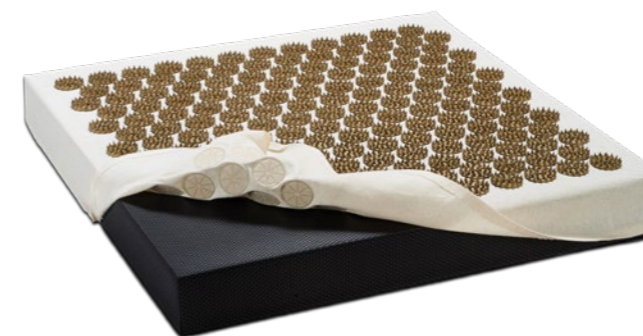

Bamusta® Cuatro

► MORE DETAILS

48 x 38 x 6 cm
Material: TPE

The quadrangular Bamusta® Cuatro is made from 60mm thick closed cellular foam material with the same excellent product characteristics as the Bamusta® Cuatro XL.

Max. carrying capacity 300 kg
Incl. sales packaging.

Colour	Article
Anthracite	9000A
Grey	9000GR
Blue	9000B
Red	9000R



▶ MORE DETAILS

Trendy Ponte

Size: 31 x 29 x 9,5 cm
Material: EVA



closed cell structure



light weight



durable



recyclable

Trendy Ponte offers you through its two sides a very extensive spectrum of possible uses. With the help of the pointed elevations and the depression in the middle, the board can be used particularly well for fascia training.

Above all, the supine position, in which pressure is created by lowering the pelvis, is particularly effective in mobilizing, stretching and strengthening the lower back.

Not only can the trigger points be determined individually, but a massage effect can also be created.

Incl. sales packaging.



Article	9117
---------	------

The effects can also be felt during fascia training while standing, as the foot is mobilized and the balance is strengthened. In addition, the calf is stretched, the foot lift and balance are trained. The Trendy Ponte is not only suitable for fascia training, but also for the fitness area. It can be used as a rocker crosswise or lengthways to bring yourself off balance through conscious movements. A particular success is achieved in the areas of stabilization, balance and stretching.



2 in 1





[▶ MORE DETAILS](#) [▶ YouTube](#)

Bamusta® Placa

60 x 39 x 10 cm
Material: EVA, Plywood

With its four non-slip corner feet, the Bamusta® Placa makes firm and secure contact with the floor. The flexible feet create a gentle, challenging movement coordination and is therefore ideal for the first muscle build-up.

Max. load limit 150 kg
Incl. sales packaging.

Article 9007A



[▶ MORE DETAILS](#) [▶ YouTube](#)

Bamusta® Circulo

Ø 39 x 11 cm
Material: EVA, Plywood

challenging metatarsus



With its midfoot, the Bamusta® Circulo promotes highly demanding movement coordination in advanced use and is ideal for continuous muscle building. A round surface with a large middle foot creates unstable tilting movements.

Max. load limit 150 kg
Incl. sales packaging

Article 9009A



[▶ YouTube](#)

[▶ MORE DETAILS](#)

Bamusta® Tablero

60 x 39 x 13 cm
Material: EVA, Plywood

With its high center foot the Bamusta® Tablero encourages an even higher challenging mobility coordination in the ambitious use and is ideal for the continuous build-up of muscles. The large surface allows a variety of positions for

foot, hand and sitting. With this board you achieve an optimal balance, coordination, mobility and a good physical condition for sports. Fit with the balance-kick!

Max. carrying capacity 150 KG.
Incl. sales packaging.

Article 9008A



closed cell structure



durable



Bamusta® Dois

Ø 42,5 x 8 / 5,5 cm
Material: PP



durable



recyclable

The special thing about Bamusta® Dois Board is that you have two boards in one, because to make the exercise easier in seconds, you just have to remove the foot on the underside of the board, which in turn changes the load. Here you not only train your balance, coordination and flexibility, but also your body control.

Max carrying capacity 200 KG
Incl. new sales packaging.

▶ MORE DETAILS

Article 9092



2 in 1

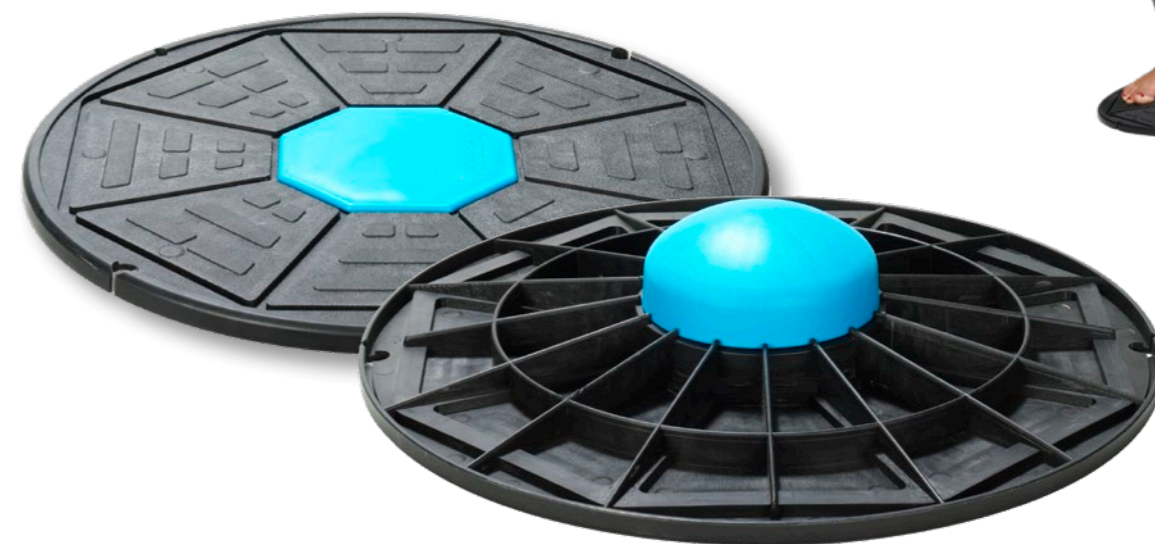

FITNESS & REHA



STEPPER



SUSPENSION TRAINER



AB WHEEL



SWING STICK



TRENDY ETAPA

NEW DESIGN
NOW in two colours available



Triple height adjustment - 15, 20 or 25 cm

► MORE DETAILS

Stepper Etapa

90 x 35 cm / Weight 7,5 KG
Material: PP, TPE, ABS



Trendy Etapa Professional gives you that extra kick for your full body workout. Train your legs, abs, back, arms and shoulders and improve your coordination and condition! The stepper is particularly easy to adjust in 3 heights, so that you can choose between a height of 15 cm, 20 cm or 25 cm depending on your

fitness level or exercise. The non-slip surface and the rubber feet also guarantee a firm and secure footing on the stepper. The stepper is available with grey or red feet. The inlay can be individualized on request.

Max. carrying capacity 150 kg.

- Compact and stackable design
- easy height adjustment
- non-slip surface
- 3 adjustable heights: 15, 20 and 25 cm
- spare parts available
- logo printing possible

Colour	Article
Grey	9095
Red	9095R



Etapa Feet

Article	9095F
---------	-------



Etapa Clips

Article	9095C
---------	-------



▶ MORE DETAILS

Stepper Reebok Professional

102 x 38,5 cm / Weight 7,5 KG
Material: PP, TPR, ABS

The Reebok Step Professional gives you that extra kick for your full body workout. The stepper fits into group training as well as at home. The robust and durable stepper enables dynamic and varied training units. It has a non-slip rubber surface and non-slip feet for a solid

training foundation. The height can be adjusted to three positions. You can raise the platform to increase the intensity of your workout and expand your training skills.

Max. carrying capacity 110 kg.

Article 9095-RE

Triple height adjustment - 15, 20 or 25 cm

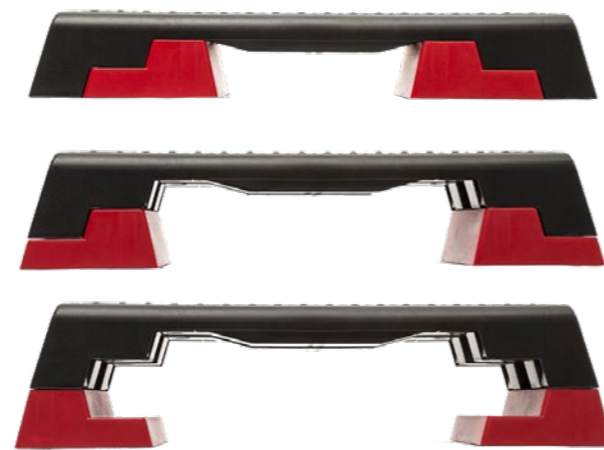

- compact and stackable design
- easy height adjustment
- 3 adjustable heights: 15, 20 and 25 cm
- antislip surface
- rubber feet prevent slipping

antislip surface



antislip



durable



recyclable



Clips

Article 9095C



▶ MORE DETAILS

Trendy Lacada

Max. length: 2,6 m, 38 cm wide
 Material: Nylon (strap), stainless steel (carabiner),
 Neoprene (pad in foot sleep)



The Trendy Lacada suspension trainer is a full-body training device for fitness, physiotherapy or home training which, with the help of your own body weight and high body tension, addresses all muscle groups extremely effectively and trains strength, coordination and flexibility.

With variable leverage and height settings, Lacada offers a very large selection of exercises while standing, sitting or lying down. Lacada can be attached to a ceiling suspension (not included) or, in the private sector, can also be clamped in the door frame using the supplied clamp fastening.

The soft neoprene pad on the foot straps provides additional comfort.

Along with our non-slip handles, secure double seams and high-quality stainless steel carabiners we offer you a training device of the highest quality!

Incl. sales packaging.



Article 5060



also for private areas: clamping in the door frame (included)

▶ MORE DETAILS

Ceiling Mount

(not included)



Article 8107

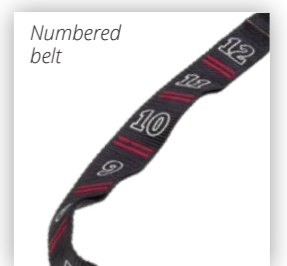
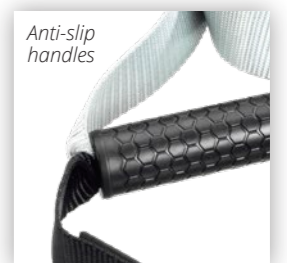



► MORE DETAILS

Chicote Rack

For 20 Chicote
30 x 35 x 120 cm

Article	5011
---------	------



► MORE DETAILS

Swing Stick Chicote

158 cm / Weight 0,75 KG
Material: Fiberglass, TPR

The Chicote Swing Stick is characterized by its various uses and applications. It is particularly popular in the areas of aerobics, stabilization and rehabilitation.

There is also a particularly positive effect in terms of stability, balance, muscle strength and endurance. The high quality of the rod ensures a high level of security.

The handles are washable, which ensures a high level of hygiene. Benefit from the dynamics that the rod creates!



Colour	Article
Anthracite	9099A
Red	9099





► MORE DETAILS

Ab Wheel Bariga

Ø 17 cm, 25 cm
Material: Steel, PP, PVC, TPR

The Bariga abdominal roller is the ideal training accessory for even more intensive abdominal muscle training.

In addition to the abdominal muscles, the back, buttocks, arm and leg muscles as well as coordination and body tension are addressed.

The training device is suitable for advanced users who already have a certain body stability.

Thanks to its compact design, the Ab Wheel is not only suitable for the fitness area, but is also always ready for use on the go. The Ab Wheel can be easily disassembled by pulling off the rubber grip caps

and stowed away even smaller. The handles offer thanks to the corrugation and the grooves a secure hold during training and that rubberized profile wheel ensures a comfortable and padded run.

Incl. sales packaging.

Article	9905
---------	------



customizable



durable



recyclable

FASCIA PRODUCTS



HAND MASSAGE ROLL



MASSAGE ROLLS



MAROLA®

PREGO®

FASCIA BALLS



FASCIA ROLLS



[▶ MORE DETAILS](#)  [YouTube](#)

Trendy Marola

Ø 13 cm / 30 cm
Material: EVA, ABS (tube and cap)

With the help of the stable and robust surface structure of the fascia massage roll, an excellent trigger point therapy can be brought about and a complete muscle massage can be achieved. This is particularly important because the everyday stress on our body can lead to one-sided stress on the muscle and fascia tissue.

As a result, the cells store more fibers, which causes the tissue to become denser and the circulation to be restricted, so that shortened and densified muscle areas are formed, so-called trigger points.

Incl. sales packaging.

Article 9102



[▶ MORE DETAILS](#)

Trendy Connector

With the Trendy connector you can connect two Trendy Marola or Prego fascia rolls to each other and thus get a 60 cm long fascia roll for an even more diverse choice between exercises while standing, lying or sitting.

To do this, you have to unscrew a cover from the roll and screw in the connector between the two rolls.

Incl. sales packaging.



Article 9122

Trendy Prego [▶ MORE DETAILS](#)

Ø 13 cm / 30 cm
Material: EVA, ABS (tube and cap)

The pyramid-shaped massage points of the Trendy Prego are especially suitable for deeper lying and more firmly seated tension in the muscle areas of the lower extremities, the back and to stabilize the trunk. The gently curved center relieves the spine and at the same time provides an intensive massage of all adjacent muscle areas. Accessories such as Trendy Bola can be stored inside the roll and closed with the screw cap.

Incl. sales packaging.



-  closed cell structure
-  light weight
-  durable
-  recyclable

Article 9104





Massage Roll Pontia

Ø 7 cm / 39 cm
Material: EVA, PP (cap), POM (tube), TPR (grip)

[▶ MORE DETAILS](#)



When using the Trendy Pontia you have an active and quick regeneration of the tissue. The soft tissue components of our connective tissue are known as fascia, which span our body like a net. The fascia are also involved in important movements and metabolic processes.

Due to the pyramid-shaped elevations, lower-lying fascia can also be reached and thus resolved as a result of regular use, which in turn promotes and increases blood circulation. Thanks to the handles, the roller is stable and secure in your hands and thus also makes it easier to reach pla-

ces such as the neck, legs, arms and shoulders. The roller covers a wide range of applications and, thanks to their comfortable size, fits in any sports bag.

Incl. sales packaging.

Article 9106



[▶ MORE DETAILS](#)

Massage Roll Ondas

Ø 7 cm / 39 cm
Material: EVA, PP (cap), POM (tube), TPR (grip)

The wave-shaped massage roller Ondas does not work as deeply into the muscles as the Pontia massage roller and acts a little more gently.

Incl. sales packaging.

Article 9107





Trendy Lua

Ø 14 cm / 33 cm
Weight: 350 g
Material: EPP

[▶ MORE DETAILS](#)

[▶ YouTube](#)

The newly revised Lua fascia roll is now available in four colours and has an even smoother surface!

The smaller fascia roll can be pulled out and used for massages in hard-to-reach areas or as a connection for an extension with a second roll. The Ø 23 mm doming can be customized on request.

The Trendy fascia roll is made of an EPP material that is very resistant and at the same time dimensionally stable.

Incl. sales packaging.

Colour	Article
Anthracite	9115A
Black/Red	9115R
Black/Blue	9115B
Black/Grey	9115GR

2 in 1 roll



- closed cell structure
- light weight
- customizable
- recyclable
- sustainable production

[▶ INDIVIDUALIZATION](#)

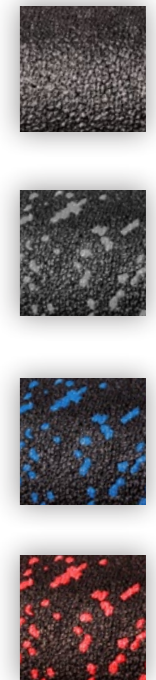

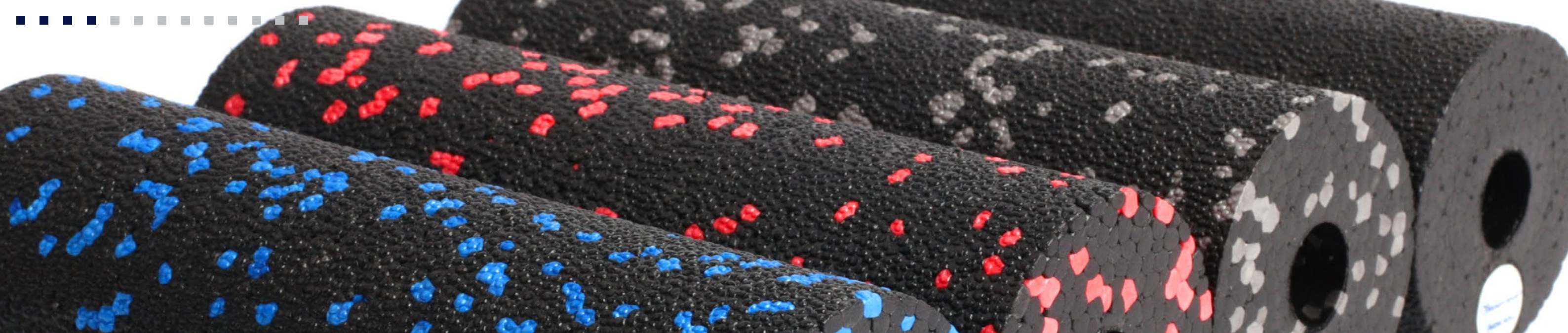

▶ MORE DETAILS ▶ INDIVIDUALIZATION



Trendy Lua Mini

15 cm x Ø 5,5 cm
Weight: 15 g
Material: EPP

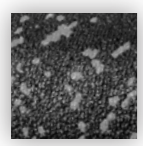

The robust Trendy Lua Mini fascia massage roll with its smooth design provides excellent trigger point therapy and a complete muscle massage. The Trendy fascia roll consists of an EPP material that is very robust and dimensionally stable.

The handy roll is also very practical on the go and can therefore be optimally integrated into everyday life. The Ø 14 mm doming can be customized on request.

Incl. sales packaging.

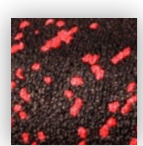
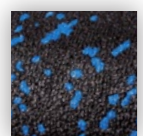

Colour	Article
Anthracite	9108A
Black/Red	9108R
Black/Blue	9108B
Black/Grey	9108GR



▶ MORE DETAILS ▶ INDIVIDUALIZATION

Fascia Set

Fascia roll Lua Mini
+ Fascia ball Bola S

Our Lua Mini fascia roll is also available as a set together with the Bola S fascia ball. The domings can be customized on request.

Incl. sales packaging.



- 
closed cell structure
- 
light weight
- 
customizable
- 
recyclable
- 
sustainable production

Article 9108SA





▶ MORE DETAILS ▶ INDIVIDUALIZATION

Fascia Ball Bola

Sizes: Ø 6cm / Ø 8 cm / Ø 10cm
 Weight: 7 g / 13 g / 31 g
 Material: EPP

The fascia ball series was mainly developed for the self-treatment of trigger points and tension. With the help of the compact size even small, deeper and therefore difficult to reach tensions in fascia and muscles can be achieved. This means that trigger point therapy can be used, which is especially important today.

Our body is exposed to a lot of stress every day, which is mainly due to an often unfavorable work posture, too

little exercise or too much stress. As a result unilateral stress can occur in muscle and fascia tissue causing the cells to begin storing more fibers. The consequences should not be underestimated as the tissues become denser and harder which reduces blood flow. This allows shortened and compressed muscle areas to form within a muscle, the so-called trigger points. These can spread to other parts of the body and cause severe pain there.

With the help of constant pressure and regular use of the fascia balls at these points, the tissue can be relaxed and the trigger points released. Choose the right size for your fascia ball and determine the intensity of your massage yourself!

Fascia Ball Bola Colour

Sizes: Ø 6cm / Ø 8 cm / Ø 10cm
 Material: EPP

Now the fascia ball is also available in gray, blue and red in all three sizes. The doming can also be customized on request.

Incl. sales packaging.



Colour/Size	Bola S	Bola M	Bola L
Anthracite	9116S	9116M	9116L
Black/Red	9116SR	9116MR	9116LR
Black/Blue	9116SB	9116MB	9116LB
Black/Grey	9116SGR	9116MGR	9116LGR

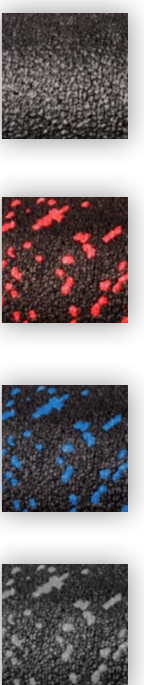



closed cell structure



light weight



customizable



recyclable



sustainable production



[▶ MORE DETAILS](#) [▶ INDIVIDUALIZATION](#)

Fascia Ball Dupla & Dupla XL

Material: EPP

The Dupla fascia ball combines two fascia balls in one and thus enables a massage of parallel muscle strands. Now the fascia ball is also available in both sizes in red, blue and grey. The doming can also be customized on request.

Incl. sales packaging.



Trendy Dupla XL

Art. No. 9110XL
24 cm / Ø 12 cm
Weight: 140 g

Trendy Dupla

Art. No. 9110
16 cm / Ø 8 cm
Weight: 31 g

Colour/Size	Dupla	Dupla XL
Anthracite	9110	9110XL
Black/Red	9110R	9110XLR
Black/Blue	9110B	9110XLB
Black/Grey	9110GR	9110XLGR

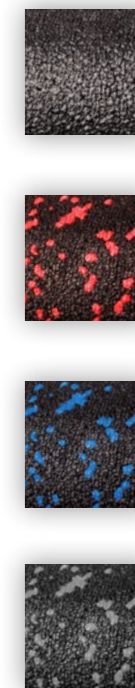



► MORE DETAILS

Spiky Ball

Sizes: Ø 7 cm / Ø 8 cm / Ø 9 cm / Ø 10 cm
Material: PVC

The therapy ball can be used to train mobility, relieve tension and promote blood circulation. Thus, the hedgehog ball can be used in many ways and enables a wide range of different uses. The different colours indicate different sizes.

Available in four different sizes.

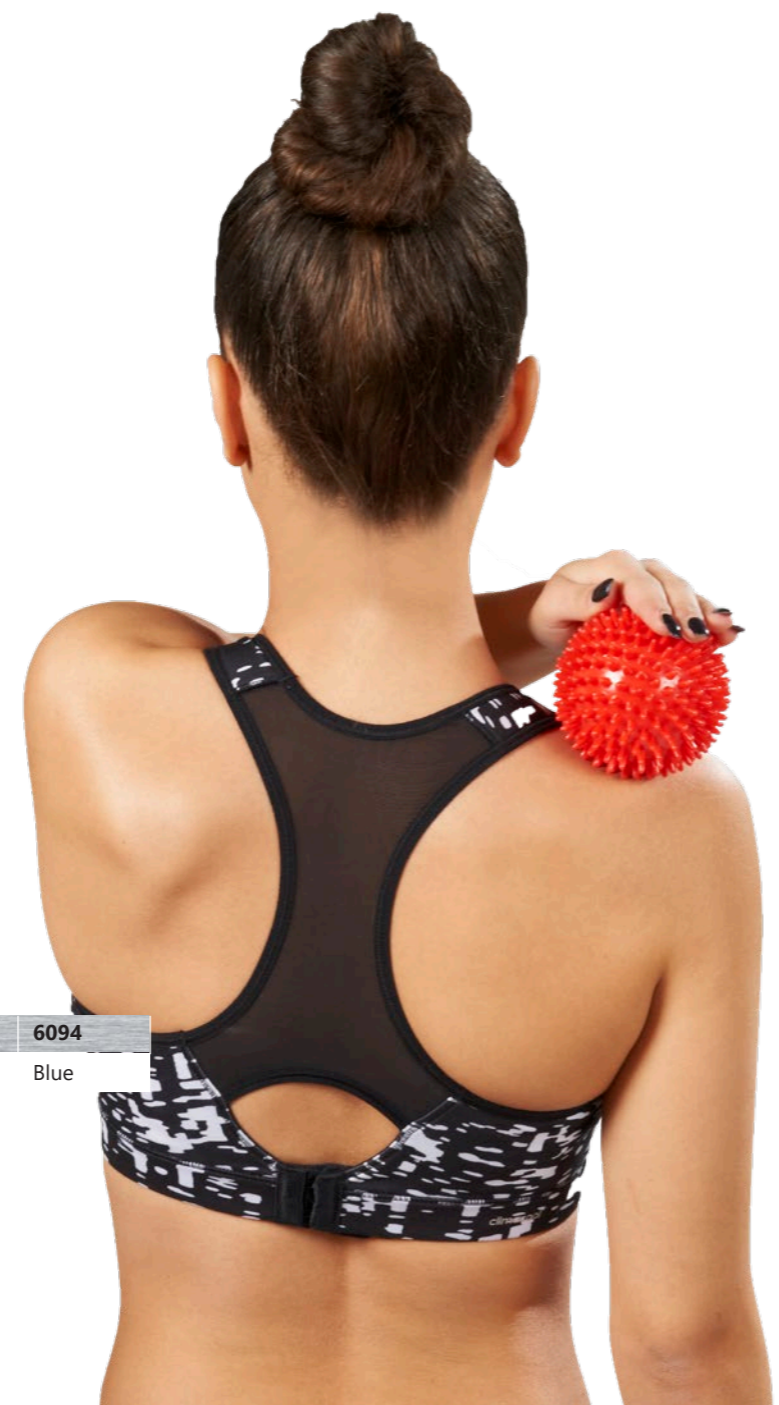

-  antibacterial protection
-  durable
-  recyclable

Article	6091	6092	6093	6094
Colour	Green	Yellow	Red	Blue

NEW CORK-LINE

NOW AVAILABLE

SUSTAINABILITY MEETS FUNCTION



Our new cork line

Our new cork product line will be available for you shortly, consisting of a two-sided yoga mat made of cork and natural rubber, a yoga block, a foam roller and two foam balls with all the advantages that the modern material has to offer.

Cork is a very robust and durable material with antibacterial and antiallergic properties. In addition, our cork product line is made from renewable raw materials, is recyclable and therefore particularly sustainable.

Fascia roll Cortica

▶ MORE DETAILS

Yoga Block cork

▶ MORE DETAILS

Yogamat Cortica

▶ MORE DETAILS



Fascia duo ball Dupla cork

▶ MORE DETAILS

Fascia ball cork

▶ MORE DETAILS

CORK LINE



FASCIA ROLLS CORK



FASCIA BALLS CORK



YOGA MAT CORK



YOGA BLOCK CORK



CORTICA

NOW AVAILABLE

▶ MORE DETAILS



Trendy Roll Cortica

30 cm x Ø 10 cm
Weight: 813 g
Material: Cork

▶ INDIVIDUALIZATION

Article 9125KO

With its smooth design, the robust Trendy Cortica fascia massage roller made of cork ensures excellent trigger point therapy and full muscle massage.

Cork is a very robust and durable material with antibacterial and antiallergic properties. In addition, our cork fascia roll is made from renewable raw materials, is recyclable and therefore particularly sustainable.

The dome can be customized on request.

Incl. sales packaging



antibacterial protection



customizable



durable



sustainable production



recyclable

New soon available

▶ MORE DETAILS

▶ INDIVIDUALIZATION

Trendy Roll Cortica Mini

15 cm x Ø 5,5 cm
Weight: 96 g
Material: Cork

The Trendy Cortica Mini fascia massage roller is particularly handy because of its small size of 15 cm and can therefore be ideally integrated into everyday life.

The dome can be customized on request.

Incl. sales packaging



Article 9108KO





NOW AVAILABLE

▶ MORE DETAILS



Fascia Ball Dupla Cork

16 x 8 cm
Weight: 154 g
Material: Cork

Trendy Dupla cork is an excellent training tool for self-massage of trigger points. Due to its shape, it has a double punctual effect and is particularly suitable for the trigger point massage of parallel muscle strands. The intensity can be determined by the pressure you exert yourself. Cork is a very robust and durable material with antibacterial and an-

tiallergic properties. In addition, our cork fascia ball is made from renewable raw materials, is recyclable and therefore particularly sustainable.

The doming can be customized on request.

Incl. sales packaging

Article 9110KO

▶ INDIVIDUALIZATION



▶ MORE DETAILS

Fascia Ball Bola Cork

8 cm
Weight: 79 g
Material: Cork

Trendy Bola Cork was specially developed for the self-treatment of trigger points and tension. Its shape makes it possible to massage even small, deeper and hard-to-reach tensions in fascia and muscles.

The doming can be customized on request.

Incl. sales packaging

▶ INDIVIDUALIZATION

Article 9116MKO



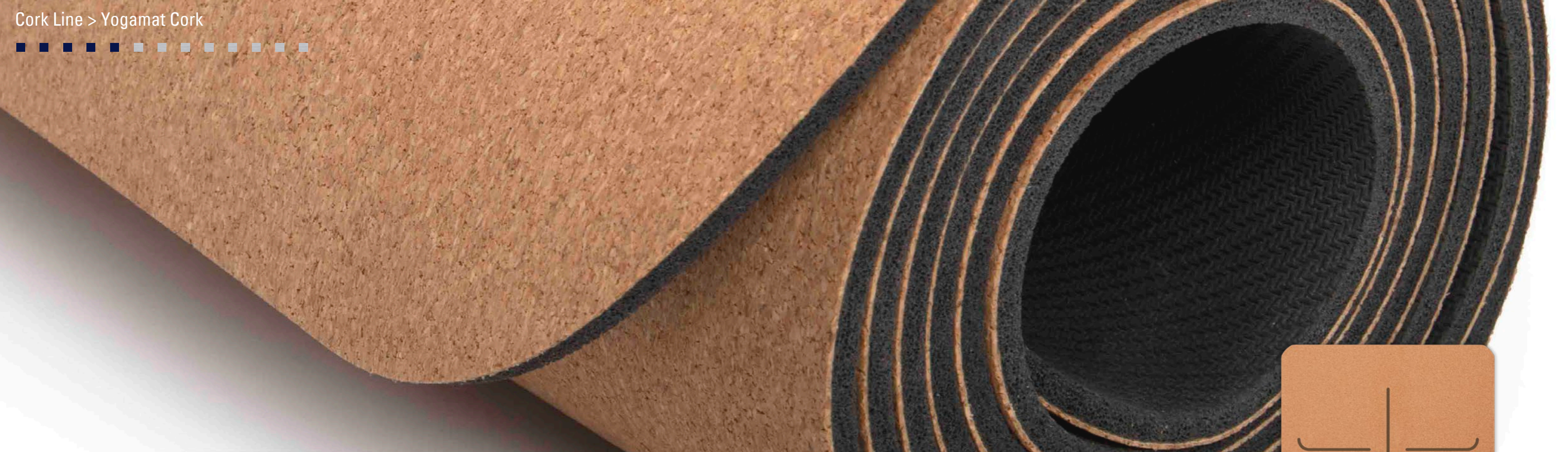





▶ MORE DETAILS ▶ INDIVIDUALIZATION

Yogamat Cortica

180 x 60 x 0,4 cm
Material: Cork, Natural Rubber

The new yoga mat Cortica combines the pleasant properties of the natural material cork with the great anti-slip properties of PU. PU also gives the mat a particularly high level of slip resistance, and its high weight ensures that the mat lies flat. Cork is a very robust and durable material with antibacterial and antiallergic properties and, like na-

tural rubber, is made from renewable raw materials, is recyclable and therefore particularly sustainable. The markings are not only a real eye-catcher, they also help you to carry out your yoga exercises correctly. The mat is therefore ideal for professional yoga, but also for your fitness training at home.

-  customizable
-  antibacterial protection
-  optimal absorption
-  durable
-  sustainable production

NOW AVAILABLE

Article 9550KO





NOW AVAILABLE

▶ MORE DETAILS

Yoga Block Cork

23 x 15 x 7,5 cm
Weight: 665 g
Material: Cork

The cork yoga block is a versatile tool for many yoga exercises. It can serve as a sitting aid, as an arm extension for particularly demanding stretching exercises. Cork is a very robust and durable material with antibacterial and antiallergic properties. In addition, our cork yoga block is made from renewable raw materials, is recyclable and therefore particularly sustainable.

Our yoga block is a real eye-catcher with its durable laser-engraved design - convince yourself of our high-quality yoga block!

Incl. sales packaging.



antibacterial protection



durable



sustainable production



recyclable



Article 9011KO

YOGA



YOGA MATS



YOGA BELTS



YOGA BLOCKS



YOGA WHEEL



MEDITATION CUSHION





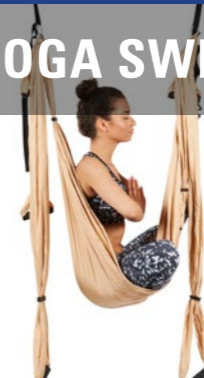

YOGA SWING





natural rubber

-  customizable
-  antibacterial protection
-  optimal absorption
-  durable
-  sustainable production

YogaMat Vidaflor

180 x 60 x 0,3 cm

Material: 65% Natural rubber, 35% PU

Our new yoga mat is characterized by its extremely good hold and elasticity. It looks particularly high-quality because of the surface and the attractive design. The mat is made of natural rubber, which is obtained from renewable raw materials and is therefore particularly sustainable.

▶ MORE DETAILS



Antislip surface

- natural rubber
- good anti-grip properties
- free from toxins
- easy cleaning

Colour	Article
Anthracite	9450A
Red	9450R
Blue	9450B
Grey	9450GR

▶ INDIVIDUALIZATION

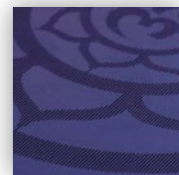



-  antibacterial protection
-  optimal absorption
-  allergy friendly
-  washable
-  customizable
-  durable
-  recyclable
-  6P FREE

also with eyelets available



Colour	without eyelet	with eyelet
Grey	9020GR	9120GR
Anthracite	9020A	9120A
Blue	9020B	9120B
Purple	9020P	9120P
Red	9020R	9120R
Orange	9020OR	9120OR
Yellow	9020Y	9120Y
Green	9020G	9120G

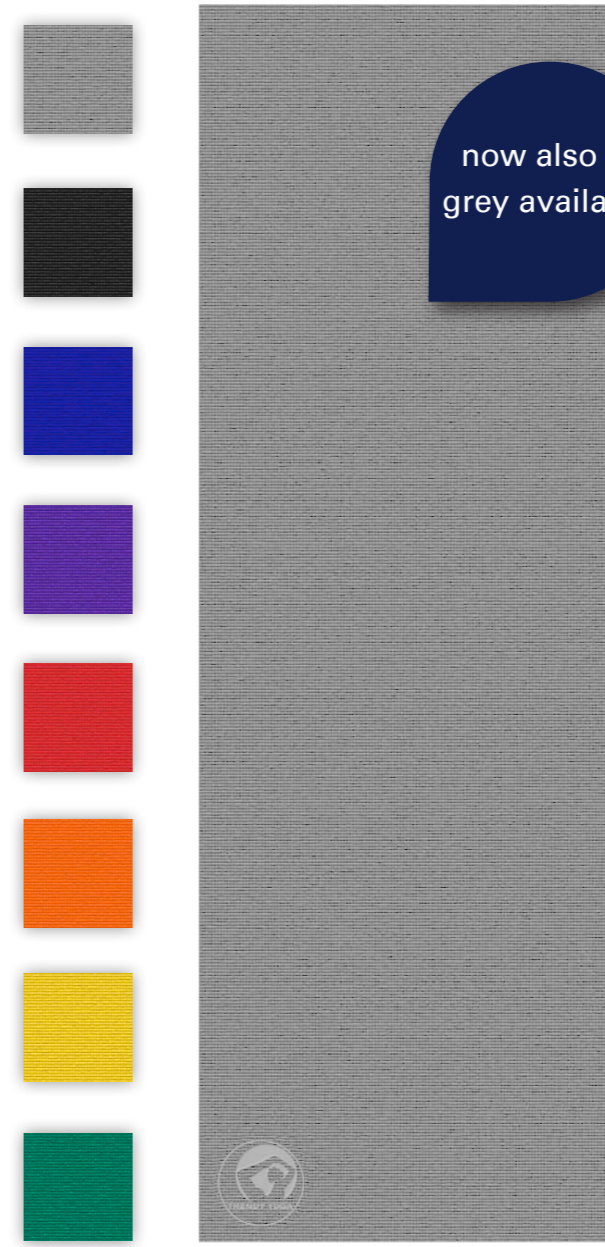

► MORE DETAILS

YogaMat Professional

180 x 60 x 0,5 cm
Material: 90% PVC, 10% Polyester, 6p free

The YogaMat Professional was specially developed for the professional yoga area and meets the high demands in all yoga areas. The absolutely non-slip mat consists of 90% PVC and 10% polyester, is 6p free and available with or without eyelets. The yoga mat can be rolled up and down effortlessly and lies nicely flat on the floor. The mat is dirt and moisture repellent, easy to clean and even washable at 30 °. Choose between our 8 colours!

► INDIVIDUALIZATION

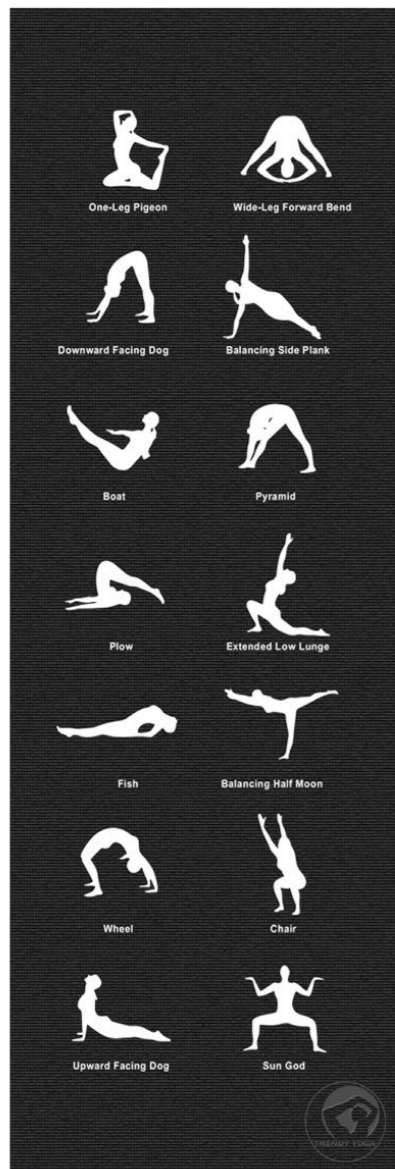
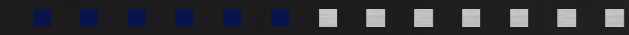

incl. carry handle



▶ MORE DETAILS

▶ INDIVIDUALIZATION

Trendy YogaMat

180 x 60 x 0,45 cm
Material: PVC

The new Trendy YogaMat was specially designed for yoga exercises at home and facilitates your training with printed exercise examples. The material is very skin-friendly and has shock-absorbing properties that are gentle on the joints. Compared to natural rubber mats, this mat is particularly suitable for allergy sufferers.

The water- and dirt-repellent surface is also easy to clean and prevents the accumulation of germs.

Colour	Article
Anthracite	9220A
Blue	9220B
Purple	9220P
Red	9220R
Orange	9220OR





▶ MORE DETAILS

Yoga Towel Toalha

183 x 63 cm
Material: Microfibre, PVC (dots)



washable



durable

The Yoga Towel Toalha is made of microfiber and is therefore extremely light, but still offers a warm and very comfortable surface for yoga, pilates and meditation. The PVC knobs on the underside guarantee

a good hold and a high level of security. Toalha is washable and therefore a very hygienic pad for your yoga training!

A bag is included in the scope of delivery.



%%%
Sale
%%%

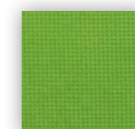
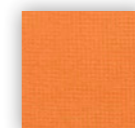
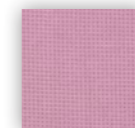
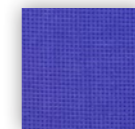
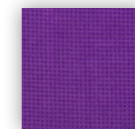
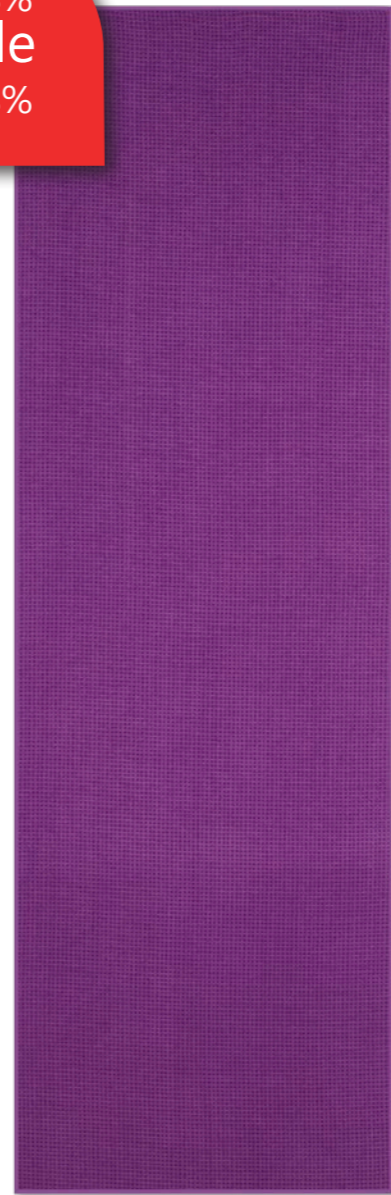

Colour	Article
Purple	9320P
Blue	9320B
Violet	9320VI
Orange	9320OR
Green	9320G

incl.
bag





► MORE DETAILS

Yoga Belt Presilha

Length: 180 cm, 10 Loops
Material: Acrylic, Rubber, Cotton

The Presilha yoga belt is an ideal training aid, especially in the areas of pilates and yoga, as well as for physiotherapeutic exercises, as well as pre- or post-training stretching.

Incl. sales packaging.



washable



durable

Thanks to the loops, many different grip positions with feet and hands are possible. That is why the Yoga Presilha is irreplaceable as a stretching aid. As a training aid, Yoga Presilha can not only correct bad posture, but also improve flexibility and the range of motion.

- stretching and expansion aid
- foot can be placed in different positions
- correction of deficiencies and body shape
- flexibility and range of motion can be improved

Article 9014





► MORE DETAILS

Trendy Yoga Belt

300 x 4 x 0,2 cm
Material: Cotton

The yoga belt not only guarantees you a more precise execution of various exercises, but also significantly reduces the risk of overstretching. The belt also makes it easier for beginners to enter the world of yoga. The clasp made of two metal rings is particularly robust and popular. The yoga belt is available in four different colours!

Colour	Article
Anthracite	9013A
Blue	9013B
Red	9013R
Grey	9013GR

100% cotton

now also grey available



► MORE DETAILS

Yoga Belt Nature

300 x 4 x 0,2 cm
Material: Cotton

The natural look of the Yoga Belt nature fits perfectly in the natural yoga product environment.

100% cotton



Article	9013N
---------	-------



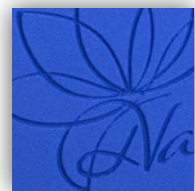
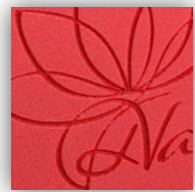
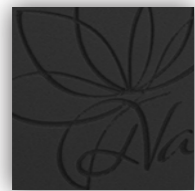

light weight



durable



recyclable

The 200g block is now even more stable and available in four different colours, 7,5 cm thick.

Incl. new sales packaging.

Yoga Block

23 x 15 x 7,5 cm
Weight: 200 g
Material: EVA

[▶ MORE DETAILS](#)

The yoga block not only helps beginners with the implementation, but also guarantees advanced users correct execution of more complex exercises and is therefore an indispensable training aid for various yoga exercises.



Colour	Article
Anthracite	9011A
Red	9011R
Blue	9011B
Grey	9011GR



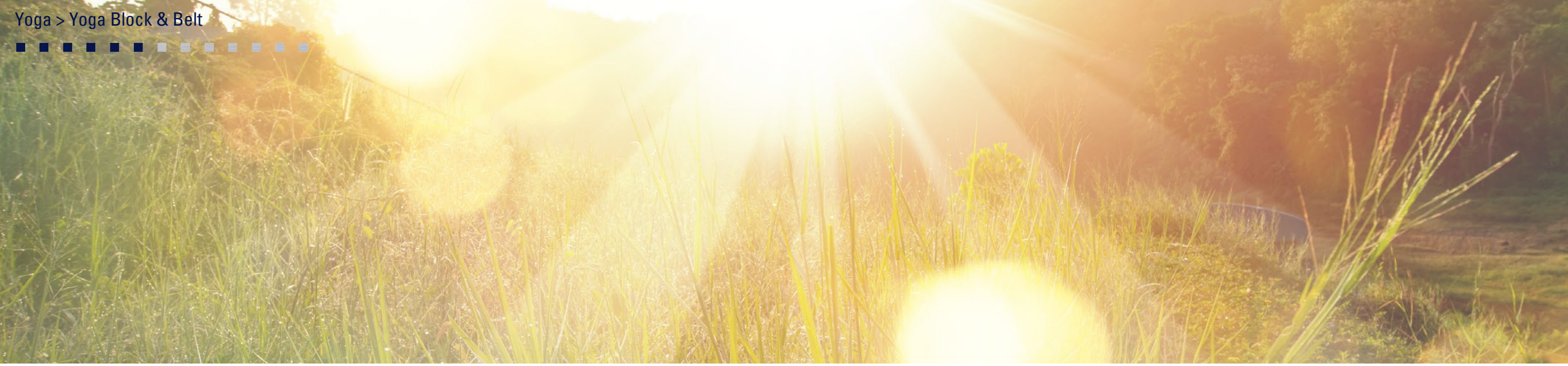

▶ MORE DETAILS

Yoga Block Bamboo

23 x 15 x 7,5 cm
Weight: 621 g
Material: Bamboo

The yoga block Bamboo helps advanced learners to intensify their exercises in order to achieve greater success, while beginners achieve postures that would not even be possible without the block. Thanks to its cell-closed bamboo material, the block achieves a high level of hygiene and is characterized by its lightness and stability.

Incl. sales packaging.



Article 9011BA



light weight



sustainable production



recyclable





► MORE DETAILS

antislip
surface

Yoga Wheel Roda

Ø 32 cm / 13 cm
Material: TPE, ABS

Stretching - bending - massaging - balancing - stabilizing - our trendy Roda Yoga Wheel is a versatile training device and can be incorporated into various yoga exercises. It helps beginners to approach difficult exercises, advanced users can deepen positions. Trendy Roda supports you in building muscles, promotes mobility and helps to relieve tension.

Article 9060



antislip



durable

Stretching and warm-up exercises can be performed even more safely thanks to the anti-slip surface on the outside. The wood look gives the yoga wheel a very elegant and natural look. Convince yourself of the high quality of our yoga wheel!

Max. weight capacity 475 kg
Incl. sales packaging.





► MORE DETAILS

Yoga Swing Impulso

Material: Nylon
2,8 x 1,5 m

With the Yoga Swing Impulso tension can be released and strength can be built up at the same time. The rocking leads each position in the horizontal and vertical plane into the depths of yoga.

Since most of humanity suffers from back problems, inversion therapy is an indispensable part of the Trendy Impulso. Neck and pelvic problems can also be eliminated with the appropriate exercises.

This training device convinces with numerous positive effects. These include not only a deeper breathing technique, increased sense of balance, reduction of stress and better stretching, but also an expansion in



washable



durable



recyclable

strength, flexibility. The confidence in your own body can be extremely strengthened.

The Trendy Impulso contains some loops and handles to hold on or to relieve certain parts of the body. The stable fastening material can also be purchased.

Incl. sales packaging

Scope of delivery

- 2 x Loop strap
- 6x Stainless steel carabiner
- 2x Handles with foam

Article 9015



- greater freedom of movement
- the rocking deepens the yoga positions
- much deeper breathing techniques
- increased balance and better stretching
- relieves back-, neck- and pelvic-problems



Ceiling mount

(not included)

Article 8107



Especially in our fast-paced times, it is important to find peace inside - meditation can create a balance in hectic everyday life to relax and recharge your batteries. A stable sitting posture is very important when meditating in order to be able to sit relaxed in the various meditation postures for a long time and to avoid postural damage. With a meditation seat cushion, overstressing the knees can be avoided, the weight on the back and pelvis is better distributed and blood circulation is promoted.

Silensia also facilitates a back-friendly and upright posture, which allows the chest to open and you can breathe freely.

The pillow cover is made of a pleasantly soft velvet fabric, which can be removed via a zipper on the underside of the pillow and washable at 30 °.

The Silensia cushion is filled with heat-storing and breathable buckwheat hulls, which adapt well to your seat and thus offer additional support and stability. Create your haven of calm now and breathe deeply in and out with Silensia!



washable



durable

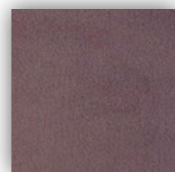
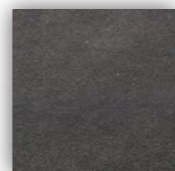

[▶ MORE DETAILS](#)

AcuReWell® - Meditation cushion Silensia

33 x 33 x 13 cm
Material: Velvet
Filling: Buckwheat hulls

Our meditation seat cushion Silensia from the AcuReWell® product range supports you in taking a comfortable and gentle sitting position during meditation.

With the dimensions 33 x 33 x 13 cm, the seat cushion is always at hand at home or in the studio and can also be an atmospheric seat and oasis of calm in your living room.

Incl. sales packaging.



Colour	Article
Anthracite	9421A
Violet	9421VI

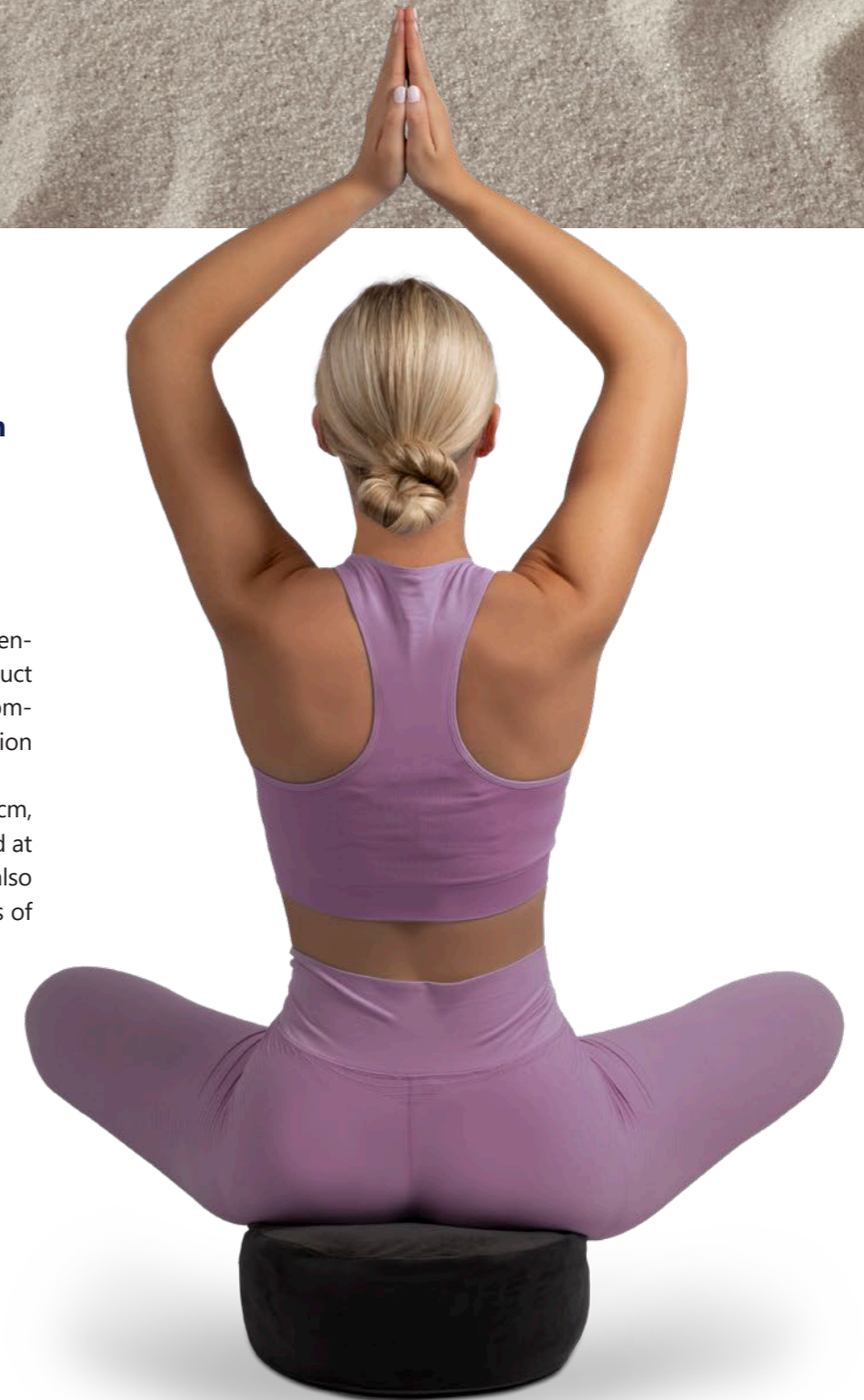

PILATES PRODUCTS



PILATES RINGS



PILATES ROLLS



PILATES BALLS





► MORE DETAILS

Pilates Ring Panelo

Ø 38 cm
Material: PP + TPR (handle),
NBR (cover), Fiberglass (inside)

The Trendy Sport Pilates ring with a diameter of 38 cm lies comfortably in the hands thanks to the anti-slip handles and the rubber coating. The space-saving training device makes your Pilates training even more varied and strengthens your arm, shoulder, chest, thigh and buttock muscles.

Incl. sales packaging.



Colour	Article
Anthracite	9056A
Grey	9056

► MORE DETAILS

Trendy Pilates Ball Melina

Sizes: ø 19 cm, ø 25 cm, ø 30 cm
Material: PVC

incl.
inflation aid

The original Trendy Pilates Ball Melina is produced of a soft foamed PVC material, can be inflated very easily with the inflating aid (blow pipe) and can be closed with the provided plug. It is a perfect training device to strengthen the back and abdominal muscles.

The Trendy Pilates Ball Melina is offering a wide range of exercises. A necessary inflation aid and plug are included in the scope of delivery.

Max. carrying capacity 60 Kg
Incl. inflation aid



Article	9051A	9052B	9053R
Size	19 cm	25 cm	30 cm
Colour	Anthracite	Blue	Red



Ø 19 cm



Ø 25 cm



Ø 30 cm



Pilates Roll Pequeno

30 cm x Ø 15 cm
Material: EVA

▶ MORE DETAILS



The soft and robust Fascia Massage Roll cares with its smooth design for excellent trigger-point therapy and complete muscle massage.

Incl. sales packaging



Colour	Article
Anthracite	9101A
Blue	9101B

▶ MORE DETAILS

Pilates Roll Largo

90 cm x Ø 15 cm
Material: EVA

Thanks to the special surface structure, this EVA pilates roll offers more slip resistance and is versatile and can be cleaned hygienically.

Colour	Article
Anthracite	9001A
Blue	9001



▶ MORE DETAILS

Pilates Roll Media

91 cm x 7,5 cm
Material: EVA

Optimal Pilates gym equipment for exercises, where upper body can recline on the dimensionally stable roll. Already proven in the fascia training and fascia massage.

Colour	Article
Anthracite	9003A
Blue	9003



▶ MORE DETAILS

Pilates Roll Mount

96 x 19 x 5 cm
Material: EVA

Our Trendy Roll Mount is used for space-saving storage of up to 5 Trendy Rolls, suitable for all rolls with 15 cm diameter.

Suitable for five pilates rolls

Colour	Article
Anthracite	9041A
Blue	9041B



closed cell structure



light weight



durable



recyclable

ACUPRESSURE ACUREWELL®

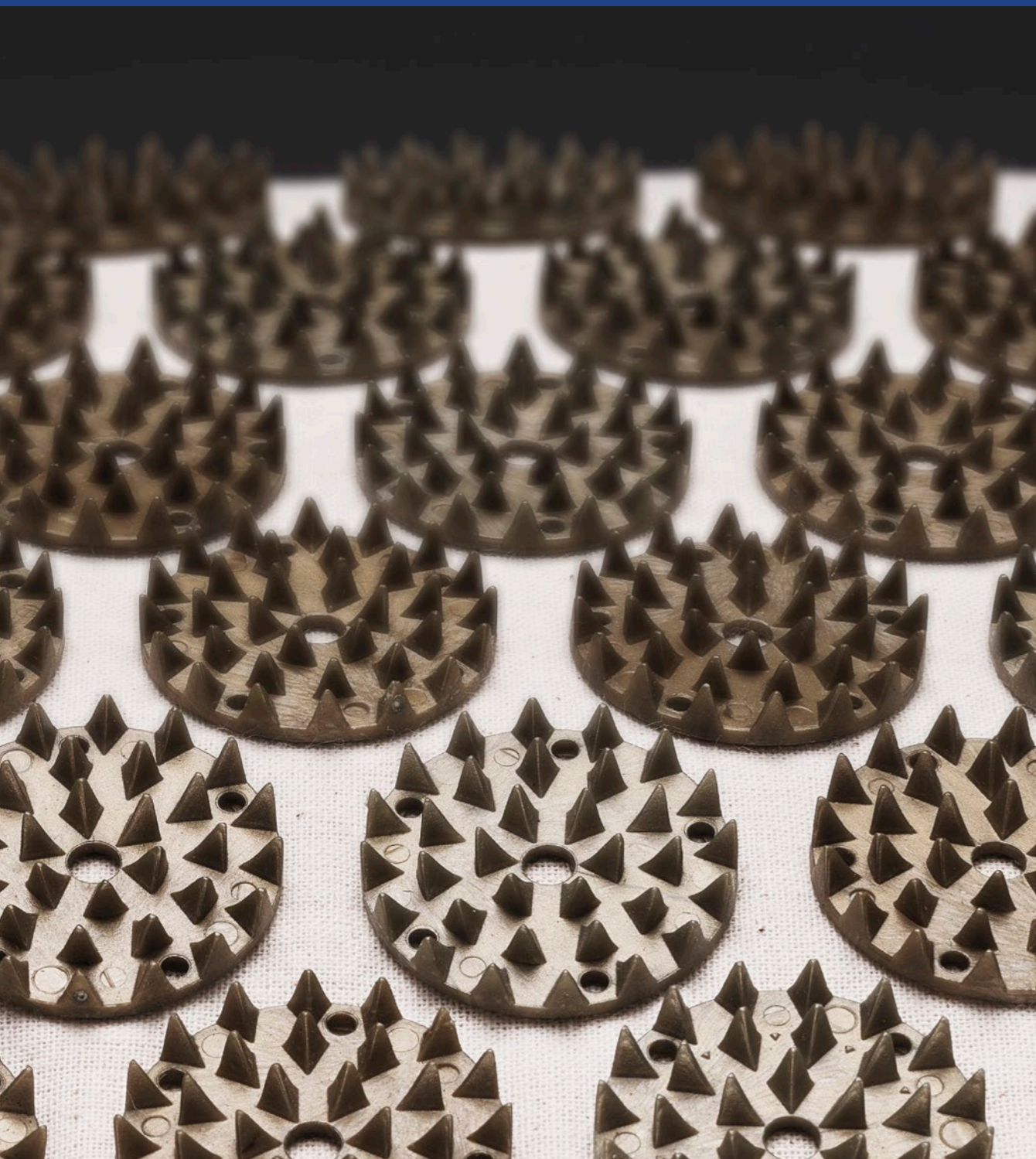

ACUREWELL® MAT



ACUREWELL® COVER

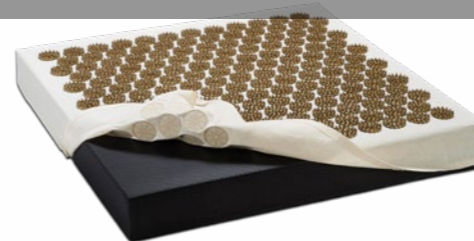

ACUREWELL®

ACUREWELL® CUSHION





▶ MORE DETAILS

AcuReWell® - Acupressure mat Picata

Size mat: 68 x 42 x 2 cm
 Size pillow: 37 x 15 x 10 cm
 Material: 100% Cotton, ABS (spikes)

The acupressure mat Picata with 180 massage points, together with the neck pillow with a further 54 massage points, can help you fight head, shoulder and neck pain. This pain is often caused by stress, little movement and poor posture.

Both acupressure products are delivered in a practical cotton bag and can be used anywhere and quickly stowed away. Both the mat cover and the cushion cover are removable and therefore easy to clean.



Article 9420N



▶ MORE DETAILS

AcuReWell® - Acupressure cover Picata for Bamusta Cuatro XL

Size: 48 x 48 cm
 Material: 100% Cotton, ABS (spikes)

This acupressure cover with 168 massage points fits perfectly on our balance pad [Bamusta® Cuatro XL](#) and thus expands its range of functions to save space. An elastic band on the back ensures that the cover cannot slip.

Article 9423N



▶ MORE DETAILS

**AcuReWell®
Acupressure pillow Picata**

30 x 40 cm
Material: 100% Cotton, ABS (spikes)
Filling: Buckwheat hulls



washable



durable



recyclable

Our new acupressure pillow Picata from the acupressure product range AcuReWell® effectively relieves your head, shoulder and neck pain, which often results from stress, little movement and poor posture. The treatment resembles a pleasant head massage and can be used anywhere and at any time with the handy pillow size of 40x30cm.

The principle of action of acupressure is based on the millennia-old tradition of Chinese medicine and ensures that the life energy flows through the body without interference via meridians and thus creates physical and psychological well-being.

The acupressure products stimulate the blood circulation through their massage pressure points and also stimulate the production of endorphins, which has a positive effect on the sensation of pain. In addition to pain relief, positive effects such as stress relief or the relief of sleep disorders are also achieved.

The products consist of 100% natural cotton and are extremely pleasant and skin-friendly due to the temperature and moisture regulating properties of the cotton.

Incl. sales packaging.

Article	9422N
---------	-------



100%
cotton

By purchasing a product made from a renewable raw material, you also support a sustainable product cycle. The AcuReWell® Picata pillow is filled with heat-retaining and breathable buckwheat husks. It adapts perfectly to your neck contour and can therefore optimally support muscle relaxation.

Treat yourself to your wellness oasis for your home NOW and relax with our AcuReWell® Picata pillow



LOOPS & TUBES



LOOPS



GYM TUBES



RUBBER BAND



antislip
silicone
coating



Light

Size: 60 x 6 cm
for Rehabilitation

Medium

Size: 66 x 7 cm
for Aerobics & Rehabilitation

Heavy

Size: 72 x 8 cm
for Aerobics & Advanced

Hip Loop

Material: 60% Nylon, 40% Latex
Inside: Silicone coating

The new Hip Loops can be used for versatile training of individual muscle groups - ideal for strengthening and stretching. The loops made of 60% nylon and 40% latex are very skin-friendly and can also be washed. The inside silicone-coating has excellent anti-grip properties, which ensures a secure hold during training.

The Hip loop is available in three different strengths, which you can easily recognize by the different colours.

Incl. sales packaging.

[▶ MORE DETAILS](#)



washable



customizable



durable

Article	69911	69912	69913
Strength	Light	Medium	Heavy
Colour	Yellow	Red	Grey





► MORE DETAILS

Trendy Tone Loops

30 x 5 cm
Material: Rubber

The Tone Loops are equally suitable for building muscle in rehabilitation and aerobics and for versatile training of individual muscle groups. The Tone Loops have no seam and are therefore extremely hard-wearing and safe. The different colours of the Tone Loops indicate different levels of difficulty.

without seams



-  antibacterial protection
-  customizable
-  durable
-  recyclable

Article	67080	67081	67082	67083	67084	67085
Strength	X-Light	Light	Medium	Heavy	X-Heavy	XX-Heavy
Colour	Orange	Yellow	Green	Red	Blue	Grey

Traction 6,8-9 KG
Thickness: 0,35 mm
for Rehabilitation



Traction 9-11 KG
Thickness: 0,5 mm
for Rehabilitation



Traction 11-13,5 KG
Thickness: 0,7 mm
for Aerobics and Rehabilitation



Traction 13,5-15,8 KG
Thickness: 0,9 mm
for Aerobics and Rehabilitation



Traction 15,8-18 KG
Thickness: 1,1 mm
for a musculature already trained



Traction 18-20 KG
Thickness: 1,3 mm
for a musculature already trained



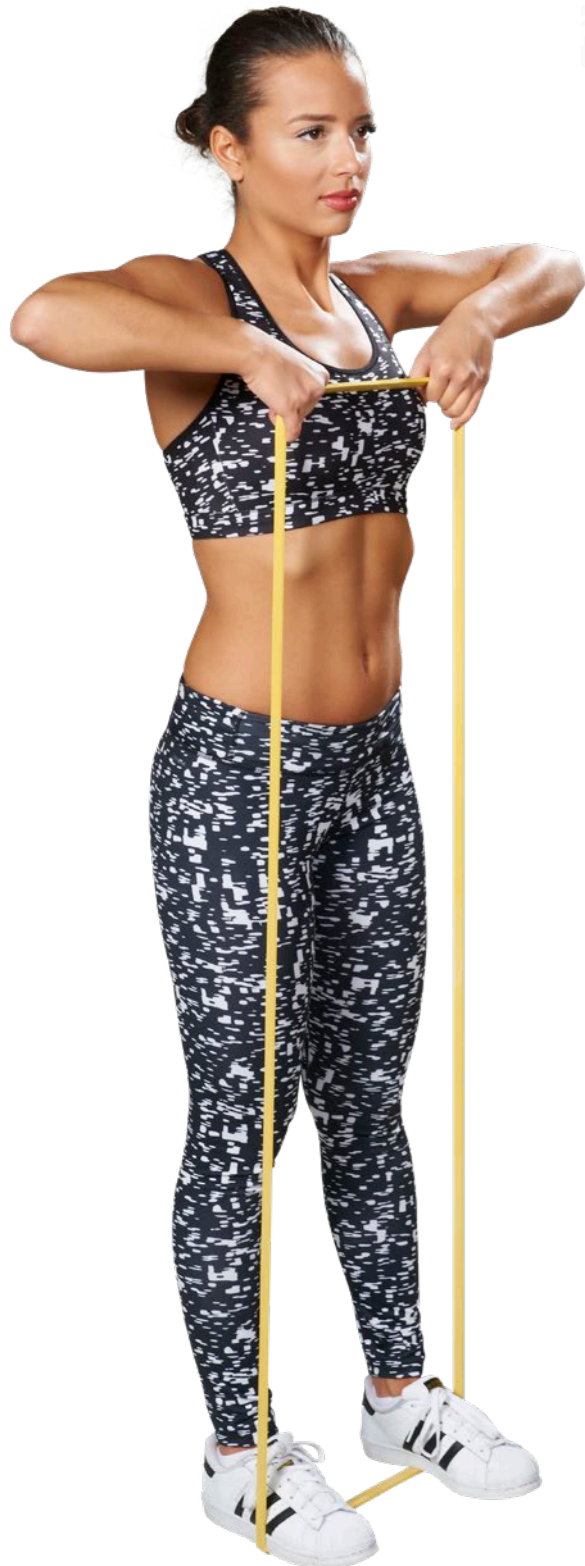

Article	67091	67092	67093	67094	67095	67096
Strength	X-Light	Light	Medium	Heavy	X-Heavy	XX-Heavy
Colour	Orange	Yellow	Green	Red	Blue	Grey

▶ MORE DETAILS

Rubber Band

Length: 105 cm
Material: Rubber

The Trendy Rubber Band produces a great effect despite its simple application, because you can train almost all muscle parts.

The tape is also very useful for rehabilitation or aerobics. The rubber tapes have no seam and are therefore extremely hard-wearing and safe. The different colours indicate different levels of difficulty.

Incl. sales packaging



without seams

Traction 7-15 KG
Thickness: 13 mm
for Rehabilitation

Traction 14-27 KG
Thickness: 17 mm
for Rehabilitation

Traction 11-29 KG
Thickness: 21 mm
for Aerobics and Rehabilitation

Traction 18-32 KG
Thickness: 26 mm
for Aerobics and Advanced

Traction 15-38 KG
Thickness: 32 mm
for a musculature already trained

Traction 22-56 KG
Thickness: 45 mm
for a musculature already trained

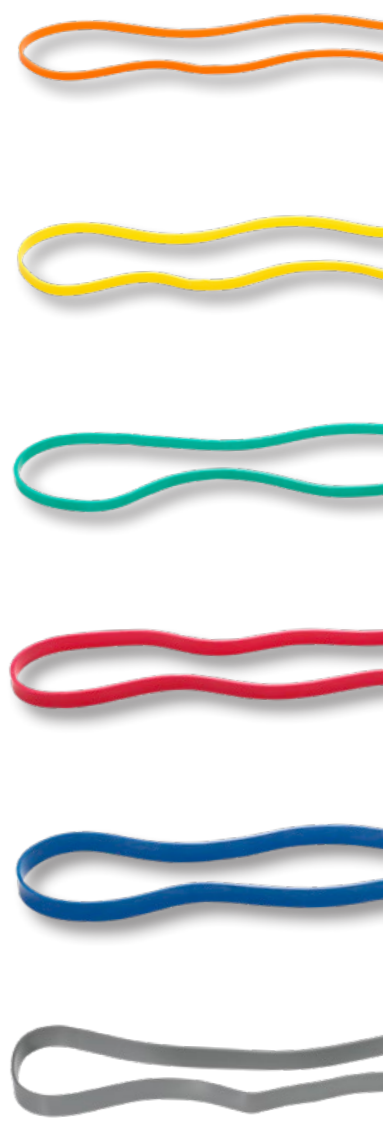



Traction up to 4,5 KG
Thickness: 0,35 mm
for Rehabilitation

Traction up to 5,5 KG
Thickness: 0,40 mm
for Rehabilitation

Traction up to 6,8 KG
Thickness: 0,45 mm
for Aerobics/Rehabilitation

Traction up to 7,8 KG
Thickness: 0,50 mm
for Aerobics/Advanced

Traction up to 9,1 KG
Thickness: 0,55 mm
for a musculature already trained

Traction up to 10 KG
Thickness: 0,60 mm
for a musculature already trained

► MORE DETAILS

Trendy Limite Roll

25 m x 15 cm
Material: Natural Latex

Trendy Limite is a 25 meter long fitness band that you can individually cut to the required length and can therefore be adapted extremely flexibly to different requirements and exercises.



- length of 25 meters for self-cutting
- Trendy Limite box with slot
- high quality material
- extremely elastic

Article	67170-25	67171-25	67172-25	67173-25	67174-25	67175-25
Strength	X-Light	Light	Medium	Heavy	X-Heavy	XX-Heavy
Colour	Orange	Yellow	Green	Red	Blue	Grey

► MORE DETAILS

Trendy Limite Band

2,5 m x 15 cm
Material: Natural Latex

The extremely elastic band made of skin-friendly natural rubber is suitable for gentle muscle building and stretching in the rehabilitation and fitness area. It also promotes flexibility and coordination. The limit band has a progressive pull resistance and is available in six different resistances and colours,

which means that you have the perfect choice for your level of training and opportunities for improvement.

Incl. sales packaging



Article	67170	67171	67172	67173	67174	67175
Strength	X-Light	Light	Medium	Heavy	X-Heavy	XX-Heavy
Colour	Orange	Yellow	Green	Red	Blue	Grey

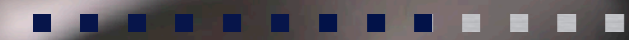

▶ MORE DETAILS

Premium Power Sleeve

Length: 160 cm
 Material: Latex, PP (sleeve, webbing)
 NBR (handle)

The Power Sleeve Tubes are characterized by their high applicability mainly in the areas of fitness, rehabilitation and aerobics. They are mainly used for stretching of the upper body and the legs. You will achieve particular success in building muscles and in improving your overall fitness and posture. The high quality material such as the nylon cover and the tight connection between handle and tube is preventing the tube from wear out and that's the correct foundation to reach your goals even faster.



Article	69811	69812	69813	69814
Strength	Light	Medium	Heavy	X-Heavy
Colour	Yellow	Green	Red	Blue



▶ MORE DETAILS

Flex Tube Rack

65 x 65 x 172
Material: Steel, coated

With the help of the Trendy Tube Rack, you can easily store up to 140 Trendy Tubes in an organized and space-saving manner.

Article 67010



Premium Gym Tube

Length: 140 cm
Material: Latex, NBR (handle),
PP (webbing)

The original Tubes by Trendy Sport are suitable to build up muscles in rehabilitation as well as for Aerobics. They are used for stretching exercises for upper body and legs. Stimulates the muscle building, improves the fitness and body alignment.

▶ MORE DETAILS



antibacterial protection



durable



antibacterial handles

resistance directly on the handle

Article	68811	68812	68813	68814
Strength	Light	Medium	Heavy	X-Heavy
Colour	Yellow	Green	Red	Blue

ACCESS CONTROL



RFID CARDS



RFID WRISTBANDS



ACESSO

RFID TAGS



New
now available

► MORE DETAILS

Chip Wristband Acceso

Diameter: 60/65 mm
Material: Silicon

Now NEW in our program:
in different designs and colors practical **key wristbands made of skin-friendly silicone.**

You can choose between the models:

- 3 designs: straight, round, oval
- 2 sizes: 60mm, 65mm
- 6 colours
- Modern Fudan 08 chip
- Frequency 13.56MHz
- Skin-friendly silicone



Design 1 - straight



Colour	Grey	Orange	Red	Blue	Green	Anthracite
Design 1 straight	67020GR	67020OR	67020R	67020B	67020G	67020A
Design 2 round	67021GR	67021OR	67021R	67021B	67021G	67021A
Design 3 oval	67022GR	67022OR	67022R	67022B	67022G	67022A

We can customize the wristband with your logo.

You have the choice between:

- One colour print
- One colour print engraving
- Two colour print
- Two colour print engraving

Please contact us for more information and consultation!

Printing surface:

- Design 1 - straight: 60 x 15 mm
- Design 2 - round: Ø25 mm
- Design 3 - oval: Ø20 mm



***After approval for printing, we will deliver your order to you worldwide within 30 days for a surcharge of 175 € / 1000 pieces.**



Example for 1c print with engraving



▶ MORE DETAILS

RFID Card Acceso

Art. No. 67025
Size: 85 x 54 x 0,8 mm
Material: Plastic

Now NEW in our program:
practical key cards made of durable plastic including 4c printing

- Glossy or mat finish
- Modern Fudan 08 chip
- Frequency 13.56MHz
- Individually printable



New
now available

▶ MORE DETAILS

RFID Tag Acceso

Art. No. 67026
45 x 30 x 4 mm
Material: Plastic, epoxy

Now NEW in our program:
practical key tag made of durable epoxy resin including 4c printing

- Glossy or matte finish
- Modern Fudan 08 chip
- Frequency 13.56MHz
- Individually printable

New
now available



EXPRESS SERVICE
30 days

***After approval for printing, we will deliver your order to you worldwide within 30 days for a surcharge of 175 € / 1000 pieces.**



Design example

EXPRESS SERVICE
30 days

***After approval for printing, we will deliver your order to you worldwide within 30 days for a surcharge of 175 € / 1000 pieces.**



Design example

ATS® LINE

ATS® DROP PADS



ATS® DISKS



ATS® BARS



ATS® PULL UP BAR



ATS® ACCESSORIES



ATS® POWER SLED



ATS® PLYO BOX





▶ MORE DETAILS

ATS® Premium Polyurethan Disk

Inside diameter: Ø 50 mm
Material: Cast iron, PU

Our new Aperto Trendy Sport® polyurethane disks impress with their unique design - with the black matt surface, which is interrupted by grey sporty lines, they not only set new optical standards in weight training and fit on any barbell with a 50 mm diameter.



Thanks to the PU coating, the disks are extremely abrasion and scratch resistant and therefore very durable. The four integrated anti-slip handles ensure ergonomic handling. The ATS® disks are available in seven different weight levels from 1,25 Kg to 25 Kg.



antislip



antibacterial protection



durable

Article	3010-0125	3010-0250	3010-0500	3010-1000	3010-1500	3010-2000	3010-2500
KG	1,25 kg	2,5 kg	5 kg	10 kg	15 kg	20 kg	25 kg
Outside dia.	195 mm	230 mm	280 mm	360 mm	370 mm	450 mm	450 mm
Thickness	20 mm	25 mm	30 mm	30 mm	40 mm	40 mm	50 mm

100% recycled rubber





▶ MORE DETAILS

ATS® Premium Bumper Plates

Inside diameter: Ø 50 mm
 Outside diameter: Ø 450 mm
 Material: 100% Rubber

Our new Aperto Trendy Sport® Premium Bumper Plates in exclusive Trendy Sport Design offer you an even larger selection of high-quality equipment for your strength training! The weight plates consist of 100% recycled rubber granulate and are therefore not only sustainable, but also extremely durable and robust. The material makes the impact extremely quiet and gentle on the floor. Nevertheless, ATS® Rubber Disks are flexible and at the same time extremely abrasion and scratch resistant.



- 
antislip
- 
extremely good absorption
- 
very good acoustic insulation
- 
durable
- 
sustainable production

All sizes have the same diameter of 45 cm, which means that the weight is evenly distributed on the floor when you put it down, making it ideal for dynamic training. The discs fit on any dumbbell bar

with a 50 mm diameter, such as our ATS® bars, but can also be incorporated into your training without a bar. The ATS® weight plates are available in five different weight levels from 5 Kg to 25 Kg.





▶ MORE DETAILS

ATS® Disk Rack

137 x 71,5 x 61 cm
Material: Steel

With this high-quality, solid weight plate stand, you can store all plates with a hole diameter of 50 mm in a clear manner.

Length of the handrails: 31,5 cm.

Suitable for:

- 90 x 1,25 KG PU ATS plates
- 72 x 2,5 KG PU ATS plates
- 60 x 5 KG PU ATS plates
- 60 x 10 KG PU ATS plates
- 42 x 15 KG PU ATS plates
- 42 x 20 KG PU ATS plates
- 36 x 25 KG PU ATS plates

Article 3041



Suitable for:

- 54 x 5 Kg Bumper plates
- 24 x 10 Kg Bumper plates
- 18 x 15 Kg Bumper plates
- 12 x 20 Kg Bumper plates
- 12 x 25 Kg Bumper plates

ATS® Disk mobile rack

130 x 32 x 28 cm, 16 Kg
Material: Steel

This practical weight disk rack is suitable for all types of weight plates. 16 compartments offer space for narrow and wide plates and thus ensure order and overview. With the help of the transport handle and the rolls on the opposite side, the disks and rack can be moved comfortably.

Article 3045



New
soon
available



ATS®
APERTO TRENDY SPORT

▶ MORE DETAILS

ATS® Curl Barbell

Diameter: Ø 50 mm, Length 1200 mm
Material: Steel

We offer a large selection of training bars to match our ATS® Polyurethan Disks and our Premium Bumper Plates. We offer this high-quality curl barbell with a handy total length of 1200 mm and a sleeve diameter of 50 mm.

The curl bar is particularly suitable for efficient training of the biceps, triceps and shoulder muscles and, thanks to the corrugated grip surface, offers maximum safety and comfort during your training.

The training bar is made of robust hard chrome-plated solid steel and is characterized by high tensile and compressive strength with simultaneous elasticity. Together with the noble end caps and rubber rings in ATS® design, you will be amazed by the design, function and quality!

Article 3021

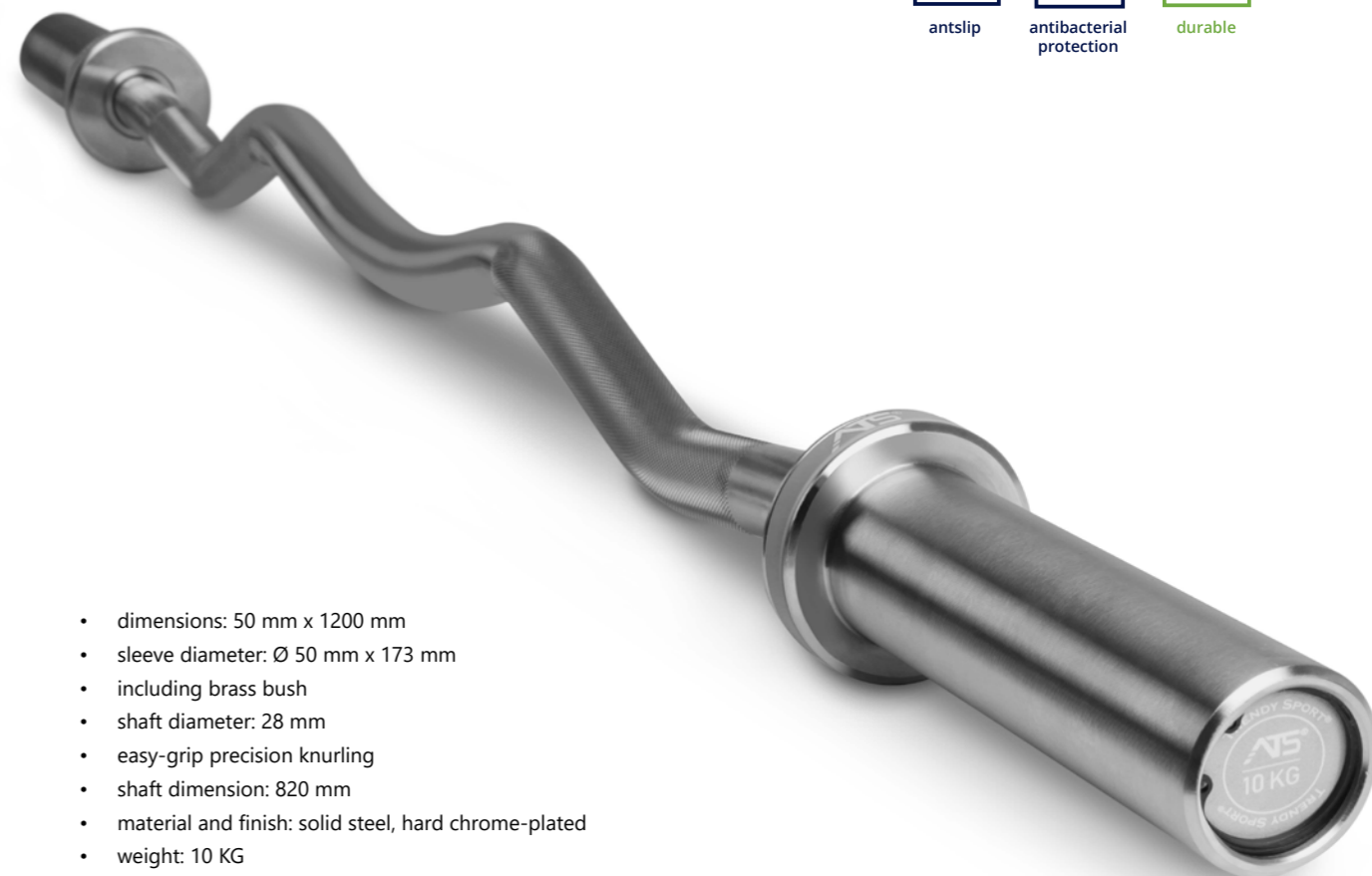

antislip



antibacterial protection



durable

- dimensions: 50 mm x 1200 mm
- sleeve diameter: Ø 50 mm x 173 mm
- including brass bush
- shaft diameter: 28 mm
- easy-grip precision knurling
- shaft dimension: 820 mm
- material and finish: solid steel, hard chrome-plated
- weight: 10 KG
- maximum weight capacity: 225 KG / 500 lbs

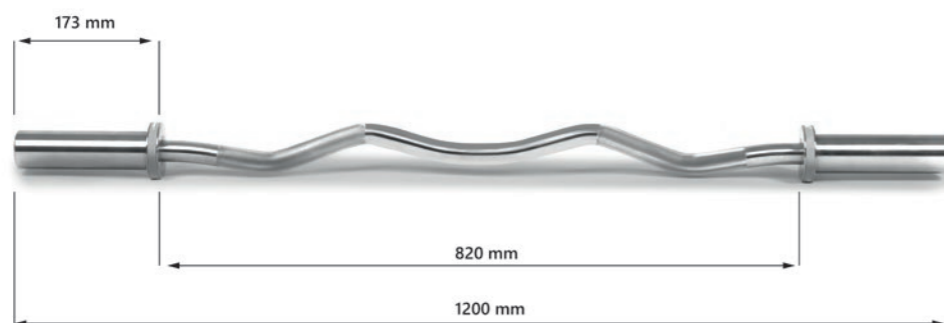



max load
225 KG /
500 lbs

- dimensions: 50 mm x 220 cm
- shaft diameter: Ø 50 mm x 410 mm
- including brass bush
- without middle mark
- shaft diameter: Ø 28 mm
- shaft dimensions: 1310 mm
- complies IPF/IWF standard
- easy-grip precision knurling
- finish: steel with hard chrome coating / black oxide coating
- weight: 20 KG
- load capacity: 225 KG / 500 lbs

► MORE DETAILS

ATS® Training Barbell 2,2 m

Diameter: Ø 50 mm, Length 2000 mm
Material: Steel

Our 2200 mm long Olympic competition bar corresponds to international basic dimensions and fits all weight plates with a shaft diameter of 50 mm for our Premium ATS® polyurethane plates.

Chromed	3023
Black Oxide	3024

With a maximum load capacity of 225 kg and a weight of 20 kg, it is suitable for both amateur and professional use, whether for powerlifting, weightlifting or bodybuilding. The integrated brass bushing ensures smooth concentricity and, together with the corrugated knurling of 440 mm, offers comfortable handling.

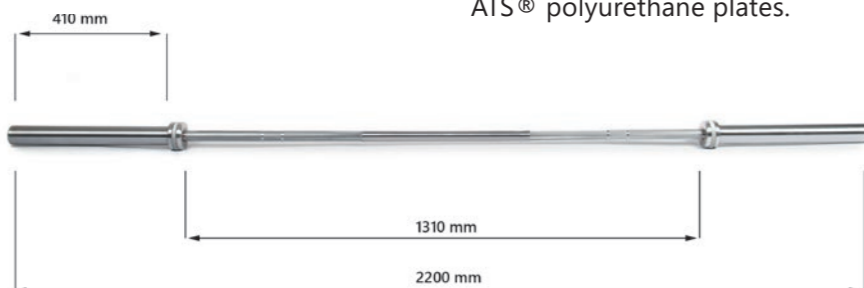

► MORE DETAILS

ATS® Training Barbell 1,8 m

Diameter: Ø 50 mm, Length 1800 mm
Material: Steel



With a total length of 1800 mm, this high-quality multifunctional barbell offers a space-saving solution compared to our 2200 mm Olympic barbells. The product convinces with a 390 mm knurled grip surface and the high-quality brass bushing, which ensures optimal concentricity in comfort and quality. The 1800 mm bar with its own weight of 13,5 kg can also be loaded with 225 kg and is ideally suited for amateur as well as professional weight lifting.

Our Barbells are made of high-quality solid steel with a timeless hard chrome coating and a cool black anodized coating and are therefore optimally protected against wear and corrosion as well as extremely tensile and pressure-resistant and yet very elastic. Together with the noble end caps and rubber rings in ATS® design, you set new design and quality standards in your home studio or professional fitness studio!

- dimensions: 50 mm x 1800 mm
- sleeve diameter: Ø 50 mm x 255 mm
- including brass bush
- without middle mark
- shaft diameter: Ø 28 mm
- shaft dimensions: 1230 mm
- complies IPF/IWF standard
- easy-grip precision knurling
- material: hard chromed steel
- weight: 13.5 KG
- load capacity: 225 KG / 500 lbs

Article	3022
---------	------

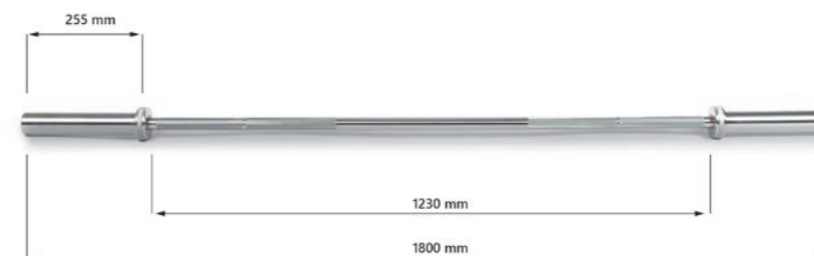



max load
680 KG /
1500 lbs

- dimensions: 50 mm x 2200 mm
- shaft diameter Ø 50 mm x 410 mm
- including brass bush without middle mark
- shaft diameter: Ø 28 mm
- shaft dimensions: 131 cm
- complies IPF/IWF standard
- easy-grip precision knurling
- material: steel with hard chrome coating / black oxide coating
- weight: 20 KG
- load capacity: 680 KG / 1500 lbs

Chromed	3025
Black Oxide	3026

► MORE DETAILS

ATS® Premium Barbell 2,2 m

Diameter: Ø 50 mm, Length 2000 mm
Material: Steel

Our 2200 mm long Olympic competition barbell corresponds to international basic dimensions and fits all weight plates with a weight plate holder of 50 mm diameter, e.g. for our Premium ATS® polyurethane plates.

With a maximum weight capacity of 680 kg and a weight of 20 kg, it is particularly suitable for professional weight training - whether powerlifting, weightlifting or bodybuilding. The integrated brass bushing ensures smooth concentricity and, together with the corrugated knurling of 440 mm, offers comfortable handling.

Our premium Olympic bars are made of high-quality solid steel with a timeless hard chrome coating and a cool black anodized coating and

are therefore optimally protected against wear and corrosion as well as extremely tensile and pressure-resistant and yet very elastic. Together with the elegant end caps and rubber rings in ATS design, you set new design and quality standards in your fitness studio!

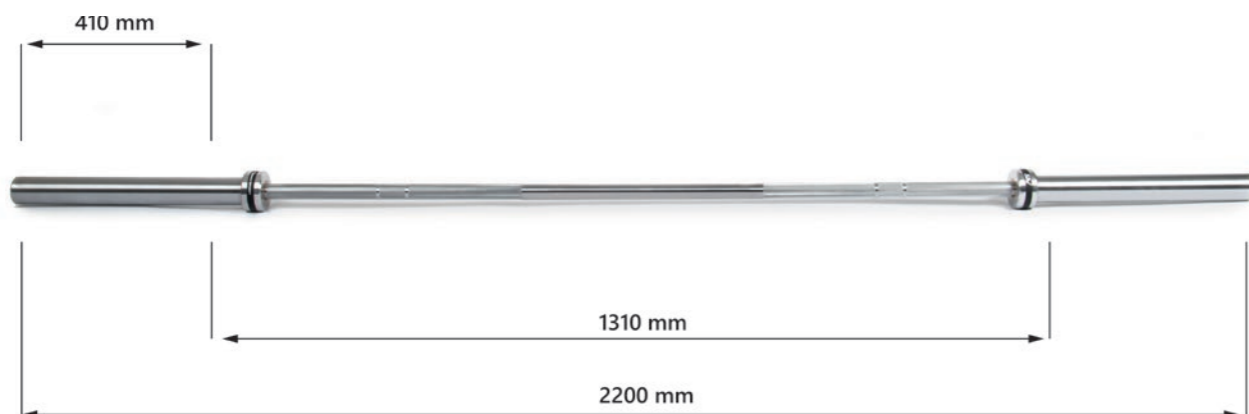



► MORE DETAILS

ATS® Triceps Trainer

Diameter: Ø 50 mm
Material: Steel

Our new triceps trainer enables a particularly ergonomic and gentle training through the natural hand position

The Triceps Trainer fits all weight plates with a weight plate holder of 50 mm diameter, e.g. for our Premium ATS® polyurethane plates.

Article 3052



- dimensions: 50 mm x 865 mm
- shaft diameter Ø 50 mm x 160 mm
- including brass bush
- easy-grip precision knurling
- material: steel electroplated
- weight: 12 KG
- load capacity: 100 KG

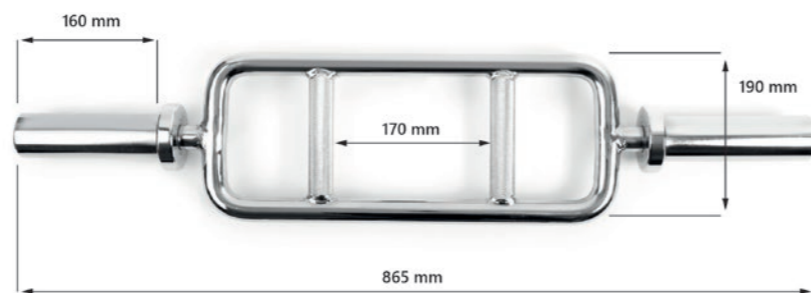

antislip



antibacterial protection



durable

► MORE DETAILS

ATS® Squat Hex Bar

Diameter: Ø 50 mm
Material: Steel

The new Squat Hex Bar enables more stable training than with barbells. You stand in the middle of the Hex bar and grasp the ribbed handles on the side, which give you a lot of grip. This makes the posture much more precise during training and you can put significantly more weight on.

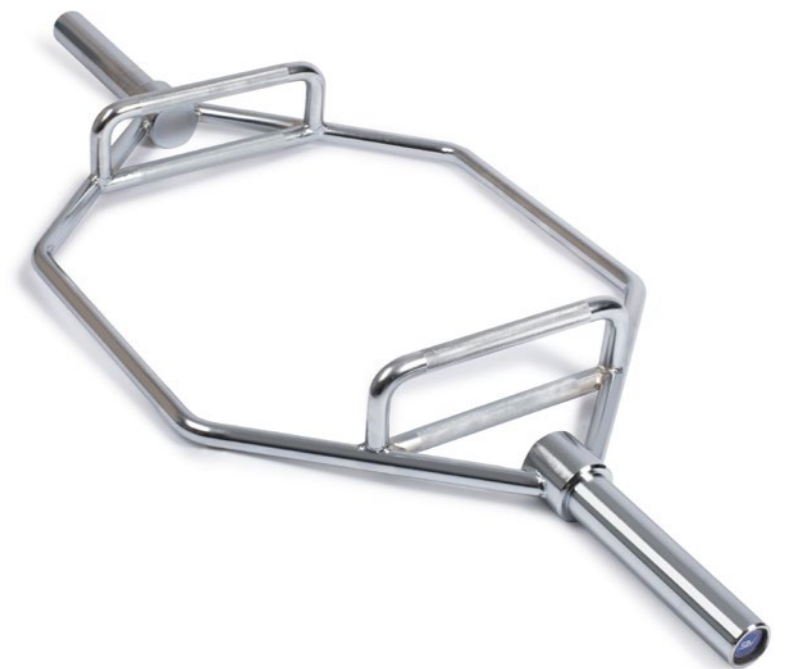

- dimensions: 50 mm x 1420 mm
- shaft diameter Ø 50 mm x 320 mm
- including brass bush
- easy-grip precision knurling
- material: steel electroplated
- weight: 20 KG
- load capacity: 150 KG

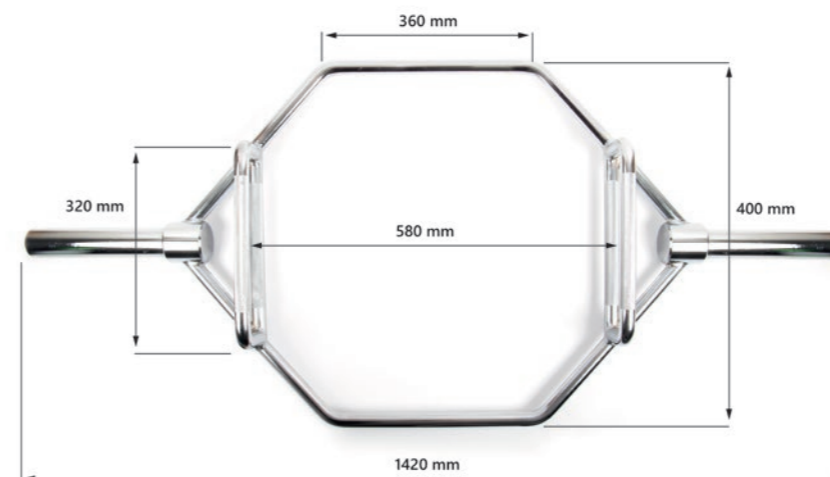

Article 3051



ATS® Neck Pad

▶ MORE DETAILS

8 x 45 cm
Material: Foam, Oxford fabric cover

Our new neck pad suitable for our ATS® barbells makes your training even more comfortable. The neck pad can be securely closed with a velcro fastener. The polyester surface is extremely hygienic and easy to clean.

Article	3053
---------	------

▶ MORE DETAILS

Spring Lock 50 mm

Material: Steel

The Spring Locks secure your weight plates optimally on your barbell and are suitable for all bars with a diameter of 50 mm.

Price per pair.

Article per pair	2058-50
------------------	---------



▶ MORE DETAILS

ATS® Secure Shutter 50 mm

Material: Aluminium

The ATS® Secure Shutters made of high-quality cast aluminum ensure extra convenience when securing and changing your weight plates. The shutter are available in plain black or silver and suitable for all bars with a diameter of 50 mm.

Price per piece.

Silver	2059GR-50
Anthracite	2059A-50



New
soon
available



ATS® Drop pads

108 x 41 x 20 cm
Material: Anti-Slip-PVC
Füllung: recycled cotton

Our new ATS steam blocks protect your floor and weights with their robust foam padding. So you can let your weights fall quietly, even on sensitive floors. Ventilation openings on the sides of the scratch-resistant cover ensure the longevity of your cushion and they can be transported easily using the handles.

- antislip
- antibacterial protection
- durable

For more than 5000 serves price in pairs.

recycled cotton



Article	3055
---------	------



New
soon
available

ATS® Plyo Box

50 x 60 x 75 cm, 20 Kg
Material: PVC-Cover, EVA padding, wood construction

With our new Plyo Box you can train your jumping power, speed, coordination and flexibility.

The soft PVC cover and the non-slip PVC surface ensure safe training and is easy to clean.

The box consists of a stable wooden construction and offers three different training heights and is therefore suitable for both beginners and advanced users.

Article 3056



New
soon
available

ATS® Pull Up Bar

127 x 84 x 50 cm
Material: Steel

Our new ATS® pull-up bar offers you the highest quality, high resilience, many different grip options and is a real eye-catcher thanks to its two-tone design!

Article 3061



New
soon
available

ATS® Power Sled

115 x 106 x 60 cm, 45 Kg
Material: Steel

Our new ATS® weight sled is the perfect training accessory for our ATS® line and, thanks to the rails, allows pull and push exercises that are gentle on the floor. Our ATS® Premium PU Disks or Premium Bumper Plates are available to match the power sled.

Article 3057





▶ MORE DETAILS

ATS® Floor Bar Holder

29 x 29 x 15,5 cm (3043)
 84 x 63 x 23 cm (3044)
 Material: Steel



This massive rack made of steel with an elegant black lacquer finish offers space for up to ten training bars. The storage stand can be screwed to the floor and, together with extreme shock resistance, offers a

high level of safety and comfort. The rack is available in two versions. The larger version can hold 10 bars, the smaller 4 bars.

Article	3043	3044
Suitable Bars	4	10



durable



▶ MORE DETAILS

ATS® Wall Mount Bar Holder

880 x 120 x 1350 mm
 Material: Steel

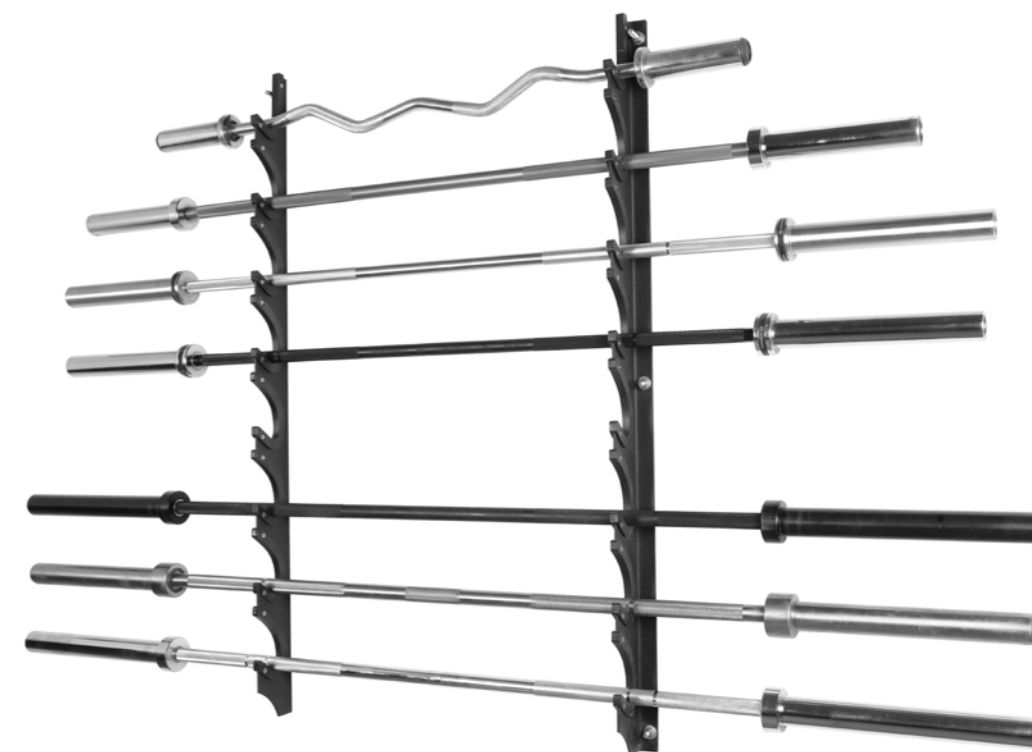

This wall mounting system can be screwed to the wall at any distance and can fit up to eight barbells.

Article	3042
Suitable Bars	8



durable

WEIGHTS



PUMP SETS

APERTO



KETTLEBELLS



DUMBBELS



FUNCTIONAL TRAINING

NEW

5

ESFERA



DUMBBEL RACK

NEW

ESFERA



1 KG
2 KG
3 KG
4 KG
5 KG
6 KG
7 KG
8 KG
9 KG
10 KG

▶ MORE DETAILS

Trendy Pesos Body Bar

Lenght 125 cm / Ø 30 mm
Material: Cast iron, PU (head),
tear-proof foam, rubber



antislip



antibacterial
protection



durable

The Pesos Body Bar is perfect for op-
timizing your workout and getting
into your workout easily.

With the help of the different weight
levels, which are colour-coded, you
can adjust the weight exactly to your
fitness level. A rubberized grip surfa-
ce gives you a particularly good grip.

Article	5001	5002	5003	5004	5005
KG	1 kg	2 kg	3 kg	4 kg	5 kg
Colour	Grey	Light Blue	Red	Green	Yellow

Article	5006	5007	5008	5009	5010
KG	6 kg	7 kg	8 kg	9 kg	10 kg
Colour	Purple	Orange	Brown	Blue	Anthracite

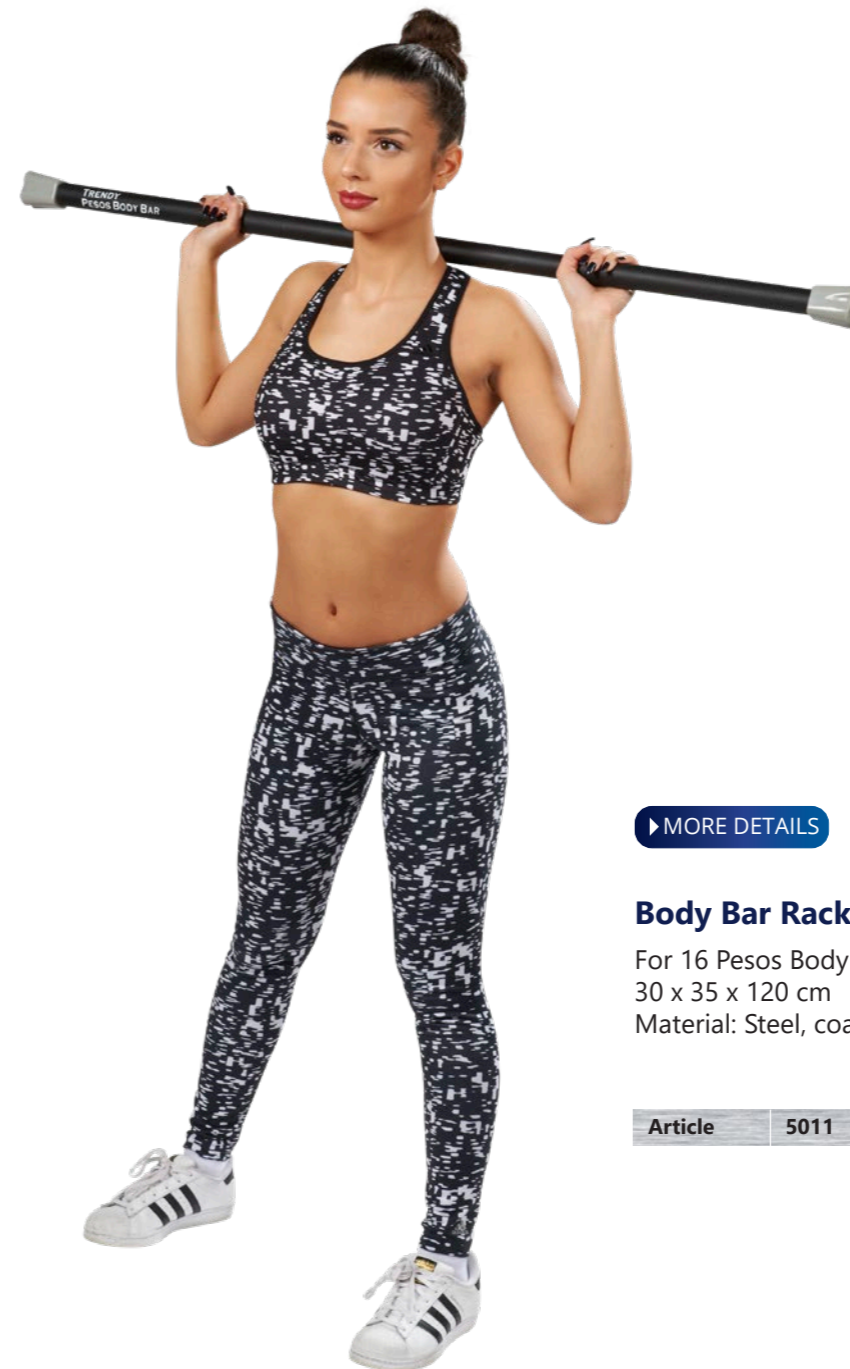

▶ MORE DETAILS

Body Bar Rack

For 16 Pesos Body Bar
30 x 35 x 120 cm
Material: Steel, coated

Article	5011
---------	------





► MORE DETAILS

Premium Pump Set RS

Total weight: 18,5 Kg

The Premium Pump Set RS consists of a 140 cm long barbell with two practical quick-release fasteners and 3 pairs of weight plates, each weighing 1,25 Kg, 2,5 Kg and 5 Kg. The disks stand out thanks to their polygonal design and high-quality surface rubber coating, which ensures that the disks can be put down almost noiselessly and protects both the floor and your disks. The integrated grip holes allow the discs to be used for numerous exercises without a bar.

Convince yourself of the quality of our premium pump set!

Article 2050PR



antislip



antibacterial protection



durable

set incl. shutter



► MORE DETAILS

Premium Pump Set Rack

For 20 Premium Pump Set RS
Material: Steel, coated

Article 2061



Set consisting of:

- 1x Bar (1kg), Ø 28mm,
- 2x Secure shutter
- 2x 1,25 kg Weight Disc
- 2x 2,50 kg Weight Disc
- 2x 5,00 kg Weight Disc

Secure Shutter

for Ø 30 mm barbell
price per pair



Secure Shutter per pair 2059



1,25 kg

Inner Ø 30 mm
Outside Ø 210 mm
Thickness 15 mm



2,5 kg

Inner Ø 30 mm
Outside Ø 230 mm
Thickness 20 mm



5 kg

Inner Ø 30 mm
Outside Ø 260 mm
Thickness 30 mm

Trendy Premium Bar RS - 1 KG

Ø 30 mm / length 1400 mm
adapter length 170 mm
max. weight capacity 20 KG





Trendy Premium Bar RS - 1 KG

Ø 30 mm / length 1400 mm
 adapter length 210 mm
 max. weight capacity 20 KG



► MORE DETAILS

Premium Pump Set Rack

For 20 Premium Pump Set RS
 Material: Steel, coated

Article 2061



Secure Shutter

for Ø 30 mm barbell
 price per pair

set incl. shutter



Secure Shutter per pair 2059

NEW

► MORE DETAILS

Pump Set TS

The new Pump Set TS, consisting of a 140 cm long barbell with two practical quick-release fasteners and 3 pairs of weight plates, each weighing 1,25 Kg, 2,5 Kg and 5 Kg, is versatile and can be used not only in the gym, but also at home.

The rubberized discs can be used alone or in combination with the bar for an effective full-body workout. Convince yourself of our new pump set!



Article 2050TS

- Set consisting of:**
- 1x Bar (1kg), Ø30 mm,
 - 2x Secure shutter
 - 2x 1,25 kg Weight Disc
 - 2x 2,50 kg Weight Disc
 - 2x 5,00 kg Weight Disc



1,25 k

Inner Ø 32 mm
 Outside Ø 185 mm
 Thickness 20 mm

2,5 kg

Inner Ø 32 mm
 Outside Ø 215 mm
 Thickness 25 mm

5 kg

Inner Ø 32 mm
 Outside Ø 245 mm
 Thickness 30 mm



► MORE DETAILS

Pesos Aperto Set A

Total weight: 18,5 kg

- 2x vinyl plates 1,25 kg
- 2x vinyl plates 2,5 kg
- 2x vinyl plates 5 kg
- 1x barbell 140 cm
- 2x spring locks

Set A Red	2050
Set A Grey	2050GR

► MORE DETAILS

Pesos Aperto Set B

Total weight: 9 kg

- 2x vinyl plates 0,5 kg
- 2x vinyl plates 1,25 kg
- 2x vinyl plates 2,5 kg
- 1x barbell 140 cm
- 2x spring locks

Set B Red	2051
Set B Grey	2051GR

► MORE DETAILS

Rack

For 16 Pesos Aperto
56 x 75 x 145 cm
Material: Steel, coated

Rack	2060
------	------

Also suitable:
Premium Pump Set
Rack Art. No. 2061

► MORE DETAILS



antislip



antibacterial protection



durable



► MORE DETAILS

Trendy Pesos Aperto

Inner Ø 30 mm
Material: Cast iron, vinyl

The Pesos Aperto disks with cast core and vinyl coating are versatile. You can individually integrate them into your training session on your Pesos Barbell and also through the handle construction.

Pesos Aperto is available in red and grey. The Aperto products can be combined individually from the range of accessories. We also offer two different sets.

Vinyl Plate Red	2053	2054	2055	2056
Vinyl Plate Grey	2053GR	2054GR	2055GR	2056GR
KG	0,5 kg	1,25 kg	2,5 kg	5 kg

Spring Locks

for Ø 28 mm barbell
price per pair

Spring Lock	2058
-------------	------

Barbell

140 cm / Ø 28 mm
Weght: 1 Kg

Barbell	2057
---------	------



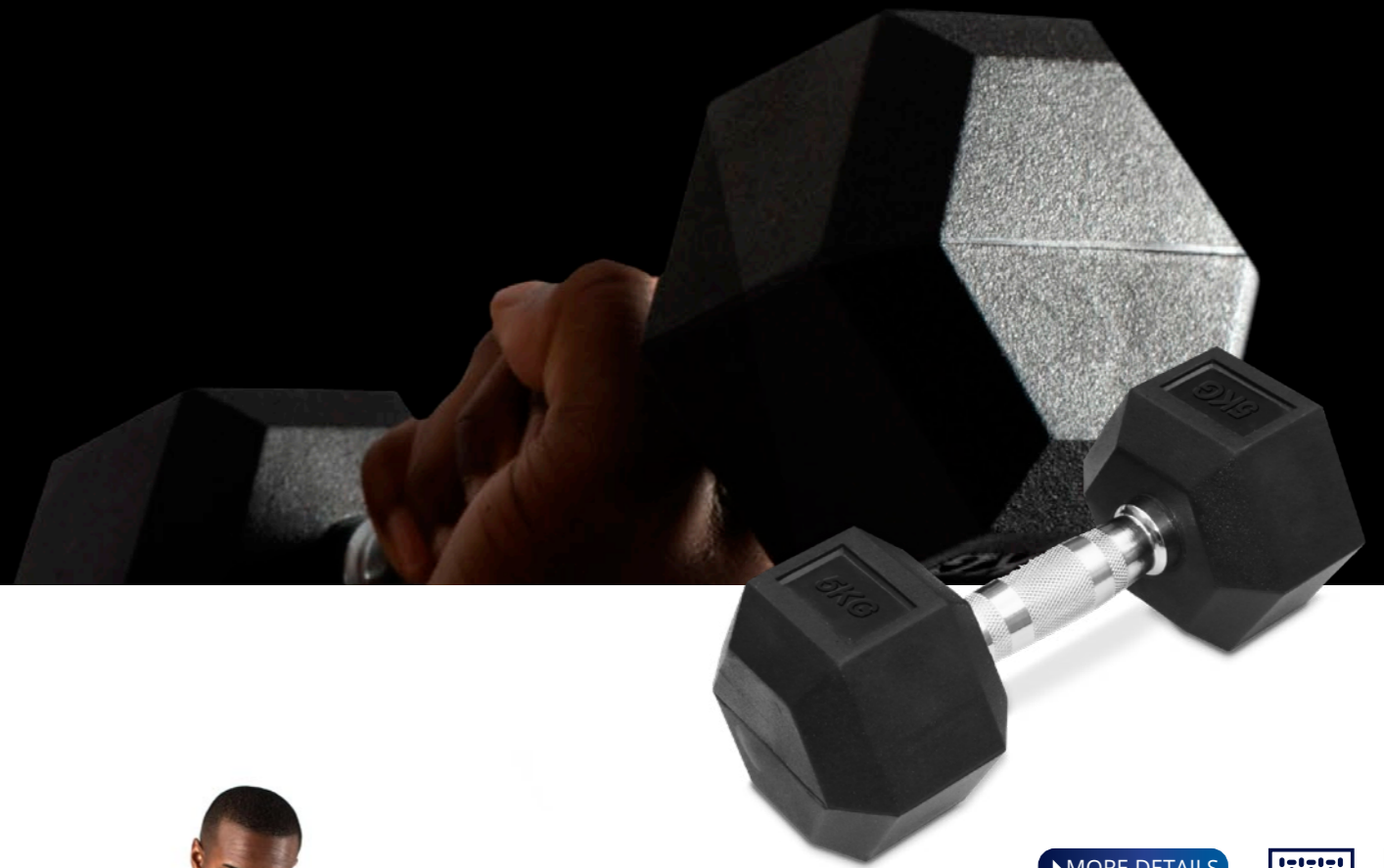
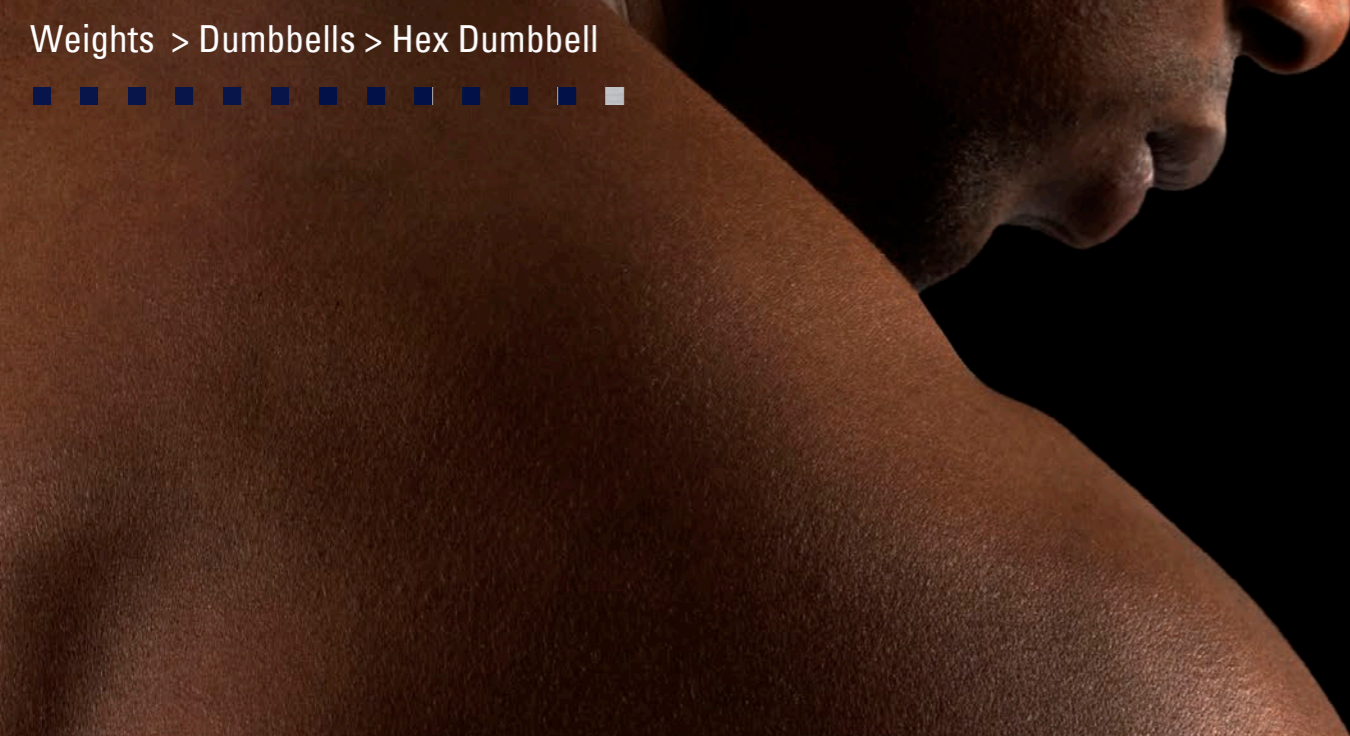

Matching [dumbbell pyramid Art. No. 2090W](#) for 10 pairs of hex dumbbells



Hex Dumbbell

1 Kg - 30 Kg
Material: Chromed steel, Rubber

The high-quality hexagonal shaped dumbbells are available in 20 sizes from 1 kg to 30 kg and therefore offer the right weight for every training level. The hexagonal shape makes the dumbbell even more robust and prevents it from rolling away.

▶ MORE DETAILS



antislip



durable

Together with the ribbed chrome-plated handle, the Hex Dumbbell offers even more comfort and safety during training. The rubber coating already covers both the dumbbell and the floor.

Dumbbell Rack for 10 pairs of dumbbells

260 x 49 x 50 cm, 58 Kg
Material: Steel

Our new dumbbell storage system offers space for at least 10 pairs of dumbbells and can be expanded as required. The rack is available in anthracite or silver grey colour.



Article	2091A	2091SG
---------	-------	--------

Article	2081010	2081020	2081025	2081030	2081040	2081050	2081060	2081070	2081075	2081080
KG	1 kg	2 kg	2,5 kg	3 kg	4 kg	5 kg	6 kg	7 kg	7,5 kg	8 kg

Article	2081090	2081100	2081125	2081150	2081175	2081200	2081225	2081250	2081275	2081300
KG	9 kg	10 kg	12,5 kg	15 kg	17,5 kg	20 kg	22,5 kg	25 kg	27,5 kg	30 kg



► MORE DETAILS

Pyramid

For 10 pairs of chrome dumbbells
73 x 59 x 155 cm
Material: steel, coated

With the help of the dumbbell rack, you have an orderly storage system and a high level of security. Fits ten pairs of chrome dumbbells.

Available in white and silver grey

Colour	Article
Silver grey	2090SG
White	2090W



► MORE DETAILS

Chrome Dumbbell Set

1 KG to 10 KG in pairs
Material: Chromed steel

The dumbbells allow an enormous range of different exercises, whereby you can decide for yourself which muscle groups you want to train.

Thanks to the ergonomic, corrugated handle, the dumbbells are particularly comfortable to hold and are therefore extremely slip-proof, even when sweaty. The chrome dumbbells can easily be cleaned with water or disinfectant.

Dumbbell Set 1-10 Kg in pairs	2080
---	-------------



antslip



durable

Article	2070	2071	2072	2073	2074	2075	2076	2077	2078	2079
KG	1 kg	2 kg	3 kg	4 kg	5 kg	6 kg	7 kg	8 kg	9 kg	10 kg



▶ MORE DETAILS

Vinyl Dumbbell

0,5 Kg - 5 Kg
Material: Steel, Vinyl coated

The vinyl dumbbells are durable and water-repellent, vinyl-coated and lie comfortably in the hand. The hexagonal shape prevents it from rolling away and the vinyl coating ensures a firm grip and is odorless. Different weight classes enable an individual improvement in performance.



Article	2021	2022	2023	2024	2025	2026	2027
KG	0,5 kg	1 kg	1,5 kg	2 kg	3 kg	4 kg	5 kg
Colour	Orange	Green	Blue	Red	Purple	Black	Black

▶ MORE DETAILS

Suporte

Rack for 60 vinyl dumbbells
56 x 75 x 145 cm
Material: Steel, coated

The rack with different spacing can optimally accommodate any vinyl dumbbell size.

Article 2020SG





▶ MORE DETAILS

Kettlebell Rack

120 x 52 x 75 cm
Suitable for all kettlebells

Article	6450
RRP €	278,00 €
Purchase Price €	139,00 €



durable

▶ MORE DETAILS

Exklusive Kettlebell

4 Kg - 24 Kg
Material: Cast iron, steel, rubber

The Exklusive Kettlebells have an impressively unique design. Their look satisfy high quality gyms and are the perfect complement for your fitness equipment. The kettlebells are available from 4 Kg to 24 Kg. The chrome handle is developed for a safe and secure grip, the black rubber coat prevent damage to the floor.

Kettlebells are overall a good tool to increase your strength and overall fitness. You can combine kettlebells with your existing workout to increase your gains. Especially in workouts for your body center, back and hip the strengths of the kettlebells are shown.



Article	6404PR	6406PR	6408PR	6410PR	6412PR	6416PR	6420PR	6424PR
KG	4 kg	6 kg	8 kg	10 kg	12 kg	16 kg	20 kg	24 kg



▶ MORE DETAILS



Kettlebell Black

4 Kg - 36 Kg

Material: Cast iron chromed, steel, rubber

The Trendy Kettlebells Black are available from 4-36 kg. The chrome handle ensures a safe and secure grip, coded with rubber coating for safer using. With the Trendy Kettlebells Black you don't train just individual muscles, also groups of muscle areas throughout the body. Especially for the back and hip area. A high-round fitness, stamina, coordination and body control speaks for the training with our Trendy Kettlebells Black.

chrome handle



Article	6404	6406	6408	6410	6412	6416	6420	6424	6428	6432	6436
KG	4 kg	6 kg	8 kg	10 kg	12 kg	16 kg	20 kg	24 kg	28 kg	32 kg	36 kg

cast handle

▶ MORE DETAILS



Kettlebell Vinyl

4 Kg - 32 Kg

Material: Cast iron, steel, vinyl

The Trendy Kettlebells Vinyl are available from 4-32 kg, colour-coded with vinyl coating. The cast iron handle ensures a safe and secure grip. With the Trendy Kettlebells Vinyl you don't train just individual muscles, also groups of muscles areas throughout the body. Especially for the back and hip area. A high-round fitness, stamina, coordination and body control speaks for the training with our Trendy Kettlebells Vinyl.



Colour differences possible.

Article	6504	6506	6508	6510	6512	6516	6520	6524	6528	6532
KG	4 kg	6 kg	8 kg	10 kg	12 kg	16 kg	20 kg	24 kg	28 kg	32 kg
Colour	Yellow	Yellow	Red	Violet	Red	Light Blue	Purple	Blue	Grey	Black



antislip antibacterial protection durable recyclable

Esfera Slam Ball

Ø 24 cm
Material: PVC, Sand

Our new Esfera Slam Ball with a very low rebound is ideal for slams and throws, with which you can optimally train strength endurance and coordination. Due to its structure, the Slam Ball offers a very good grip during training and prevents it from rolling away. The ball is available from 2-10 kg.

Article	6702	6703	6704	6705	6706	6707	6708	6709	6710
KG	2 kg	3 kg	4 kg	5 kg	6 kg	7 kg	8 kg	9 kg	10 kg

► MORE DETAILS

Premium Esfera Ball

Size: Ø 19/23/29 cm
Material: Rubber

With the help of the Esfera Medicine Ball, you have a wide range of possible uses. The Esfera Medicine Ball is equipped with a needle valve, which ensures that you can regulate the air yourself. This enables an individual adjustment of the jumping power.

Due to its pimpled surface structure, it is particularly easy to grip, very hard-wearing and extremely durable. It is easy to wash off, which ensures a high level of hygiene. The different colours indicate different weight levels.

Article	6601	6602	6603	6604	6605	6606	6607	6608	6609	6610
KG	1 kg	2 kg	3 kg	4 kg	5 kg	6 kg	7 kg	8 kg	9 kg	10 kg
Colour	Yellow	Green	Orange	Blue	Purple	Yellow	Green	Orange	Blue	Purple
Size	Ø 19	Ø 19	Ø 23	Ø 23	Ø 23	Ø 29	Ø 29	Ø 29	Ø 29	Ø 29

► MORE DETAILS

Esfera Rack

For 5 Trendy Esfera Balls
57 x 50 x 154 cm

The stable Esfera rack can hold up to five medicine balls.

Article 6211





▶ MORE DETAILS

Trendy Esfera Bag

Length 55 cm / Ø 24 cm
Material: PVC
Filling: Sand

The Esfera weight bag appeals to many muscle groups and can therefore be used in a variety of ways. The many handles and loops enable numerous training units. With the help of the self-selectable weight levels, an intensive training can be individually adapted to your own physical performance. The special thing about the Trendy Esfera Bags is that the sandbags they contain are not

with 5 handles

sewn, but glued, which makes them burst-proof. The sandbags can be easily exchanged via a zip opening. The different colours indicate different weight levels.



-  antibacterial protection
-  durable
-  recyclable
-  6P FREE

Article	5051-05	5051-10	5051-15	5051-20	5051-25
KG	5 kg	10 kg	15 kg	20 kg	25 kg
Colour	Yellow	Green	Blue	Orange	Red

▶ MORE DETAILS

Trendy Esfera Rack

141 x 69 x 57 cm
Material: Steel, coated

With the Esfera Bag Rack you can store your Trendy Esfera Bags neatly, space-saving and above all safely. For a maximum of five trendy Esfera Bags.

Article 5051





▶ MORE DETAILS

Weight Cuffs

0,5 Kg - 3 Kg
 Material: Nylon jersey
 Filling: Sand



With our hand and foot weights in six weight levels, you can effectively intensify your training by increasing the load. The velcro fastener ensures a secure hold and stability during training and is quickly adjustable. The weight cuffs are suitable for training in fitness, therapy and rehabilitation.

Our polyester product is easy to care for and has a high quality finish, is sewn twice and filled with sand. Convince yourself of the durability and quality of our weight cuffs!

Incl. sales packaging.



Article	2041	2042	2043	2044	2045	2046
KG	0,5 Kg	1 Kg	1,5 Kg	2 Kg	2,5 Kg	3 Kg

FLOORING MATS



RUBBER FLOORING

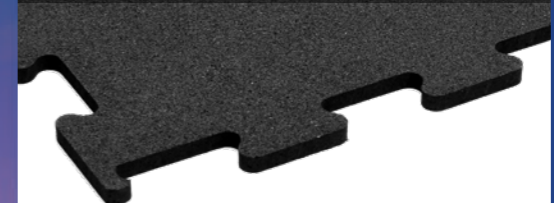

SEGURA

WEIGHT LIFT

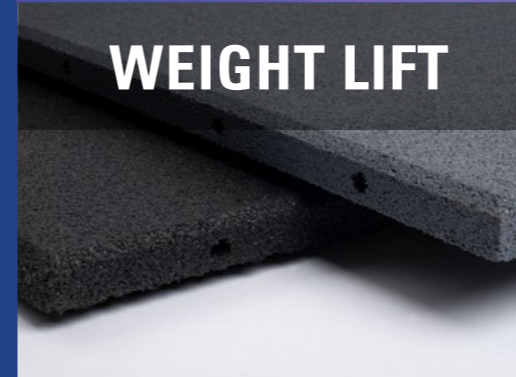

**DOUBLE
COMPETITION**

STUDIO LINE

SPORT MAT



STUDIO LINE



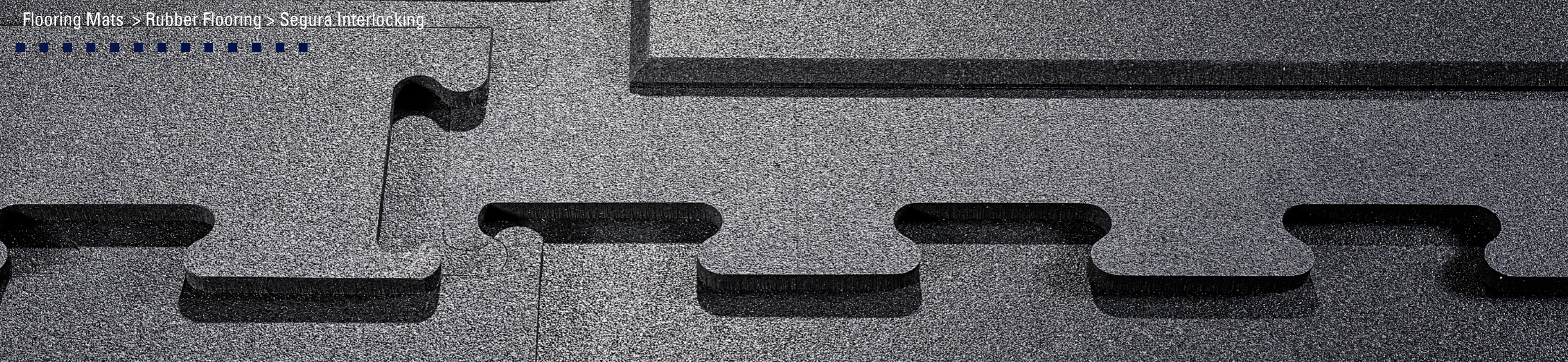

Rubber Flooring Segura Interlocking

100 x 100 cm | 1 m²
 Density: 1000 kg/m³
 Material: 100% recycled rubber

1000 kg/m³

[▶ MORE DETAILS](#)

With our Rubber Flooring Segura system, we offer you high-quality floor mats in five different thicknesses for your fitness and weight areas and thus maximum safety during training, effective noise reduction and optimal protection of your floor.

With a density of 1000 kg/m³, our mats are extremely hard-wearing and are particularly suitable for equipping professional fitness and weight training areas. Our long-lasting system in classic black

consists of 100% recyclable and environmentally friendly rubber granulate. It is therefore pleasantly warm, comfortable and gives a joint-friendly running feeling.

Thanks to the tooth system, the mats can easily be laid loosely and do not slip due to their high weight and surface adhesion.

The 100 x 100 cm mats can be individually adapted to your room conditions and with their high abrasion resistance they are the perfect choice for use in fitness stu-

dios, playgrounds, kindergartens and much more. Tripping edges are avoided by the bevelled edge and corner strips and therefore offer additional safety and comfort. Create the right foundation for your fitness area NOW, because the premium material is tailored to the needs of your customers

antislip extremely good absorption very good acoustic insulation durable sustainable production

Segura Int.	18006A	18008A	18010A	18015A	18020A
Thickness	0,6 cm	0,8 cm	1 cm	1,5 cm	2 cm
Delivery time	3 weeks	3 weeks	In stock	In stock	3 weeks
Min. quantity	50 pcs	50 pcs	1 pc	1pc	50 pcs



100% recycled rubber

Application area	Product characteristics
<ul style="list-style-type: none"> • gyms • cardio area • dumbbell area • aerobic area • practice and therapy rooms • playgrounds • kindergartens 	<ul style="list-style-type: none"> • material: 100% rubber granulate • density: 1000 kg/m³ • sustainability - 100% recycled material • high abrasion resistance • antislip property • very good sound insulation • easy installation and cleaning • edge finish with elegant bevel

Segura Interlocking Border & Corner

100 x 100 cm | 1 m²

We offer suitable end mats with a bevelled edge for the edging and corner edging. In addition to an elegant look, this also offers an additional safety aspect.

Segura Border Int.	18110A	18115A	18120A
Segura Corner Int.	18210A	18215A	18220A
Thickness	1 cm	1,5 cm	2 cm
Delivery time	In stock	In stock	3 weeks
Min. quantity	1 pc	1 pc	50 pcs

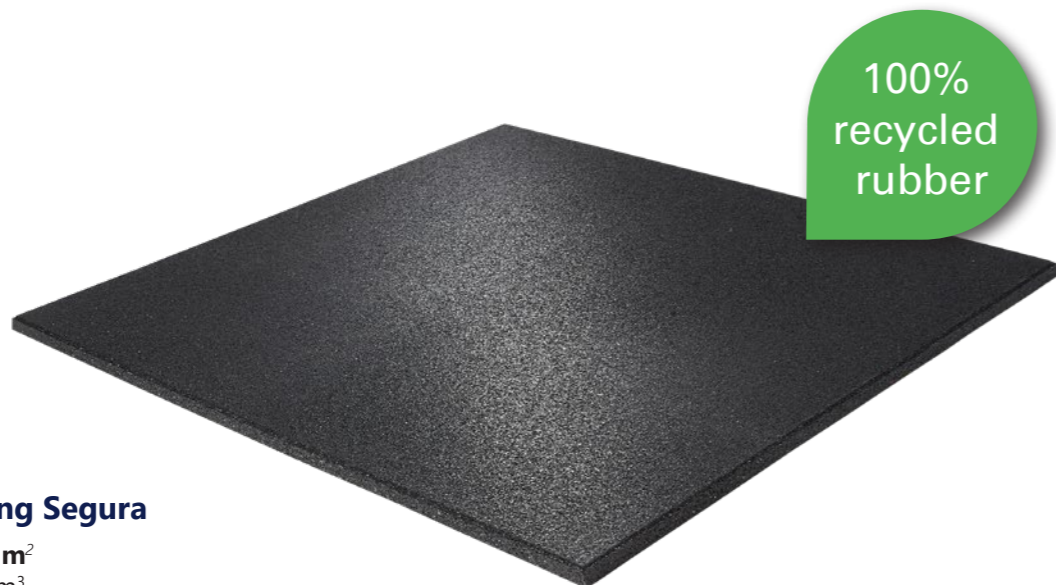

▶ MORE DETAILS

Rubber Flooring Segura

100 x 100 cm | 1 m²
 Density: 1000 kg/m³
 Material: 100% recycled rubber

The Rubber Flooring Segura system with straight edges has an even simpler look and blends in perfectly with the environment for various purposes.

1000 kg/m³

Segura	17010A	17015A	17020A
Thickness	1 cm	1,5 cm	2 cm
Delivery time	In stock	In stock	3 weeks
Min. quantity	1 pc	1pc	50 pcs



antislip



extremely good absorption



very good acoustic insulation



durable



sustainable production

Segura Border & Corner

100 x 100 cm | 1 m²
 Density: 1000 kg/m³
 Material: 100% recycled rubber

We offer suitable end mats with a bevelled edge for boarder and corner mats. In addition to an elegant look, this also offers an additional safety aspect.

Segura Border	17110A	17115A	17120A
Segura Corner	17210A	17215A	17220A
Thickness	1 cm	1,5 cm	2 cm
Delivery time	In stock	In stock	3 weeks
Min. quantity	1 pc	1 pc	50 pcs

Application area

- gyms
- cardio area
- dumbbell area
- aerobic area
- practice and therapy rooms
- playgrounds
- kindergartens

Product characteristics

- material: 100% rubber granulate
- density: 1000 kg/m³
- sustainability - 100% recycled material
- high abrasion resistance
- antislip property
- very good sound insulation
- easy installation and cleaning
- edge finish with elegant bevel

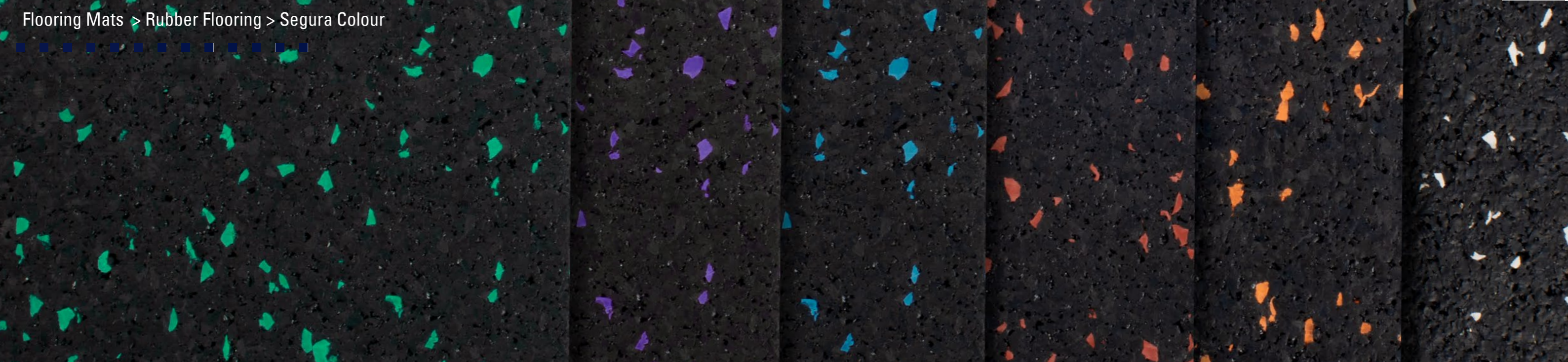

1000 kg/m³

Segura Colour
100 x 100 cm | 1 m²

Colour/Thickness	1 cm	1,5 cm	2 cm
White	17010W	17015W	17020W
Blue	17010B	17015B	17020B
Red	17010R	17015R	17020R
Green	17010G	17015G	17020G
Purple	17010P	17015P	17020P
Yellow	17010Y	17015Y	17020Y
Orange	17010OR	17015OR	17020OR

Segura Colour Border
100 x 100 cm | 1 m²

Colour/Thickness	1 cm	1,5 cm	2 cm
White	17110W	17115W	17120W
Blue	17110B	17115B	17120B
Red	17110R	17115R	17120R
Green	17110G	17115G	17120G
Purple	17110P	17115P	17120P
Yellow	17110Y	17115Y	17120Y
Orange	17110OR	17115OR	17120OR

100% recycled rubber

Segura Colour Interlocking
100 x 100 cm | 1 m²

Colour/Thickness	0,6 cm	0,8 cm	1 cm	1,5 cm	2 cm
White	18006W	18008W	18010W	18015W	18020W
Blue	18006B	18008B	18010B	18015B	18020B
Red	18006R	18008R	18010R	18015R	18020R
Green	18006G	18008G	18010G	18015G	18020G
Purple	18006P	18008P	18010P	18015P	18020P
Yellow	18006Y	18008Y	18010Y	18015Y	18020Y
Orange	18006OR	18008OR	18010OR	18015OR	18020OR

All coloured mats can be ordered with a minimum quantity of 50 pieces and delivery time of 2-3 weeks. Thickness up to 5 cm available.

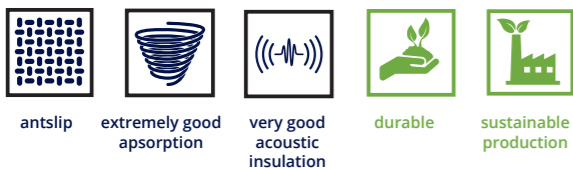

Segura Colour Corner
100 x 100 cm | 1 m²

Colour/Thickness	1 cm	1,5 cm	2 cm
White	17210W	17215W	17220W
Blue	17210B	17215B	17220B
Red	17210R	17215R	17220R
Green	17210G	17215G	17220G
Purple	17210P	17215P	17220P
Yellow	17210Y	17215Y	17220Y
Orange	17210OR	17215OR	17220OR

Segura Colour Interlocking Border
100 x 100 cm | 1 m²

Colour/Thickness	1 cm	1,5 cm	2 cm
White	18110W	18115W	18120W
Blue	18110B	18115B	18120B
Red	18110R	18115R	18120R
Green	18110G	18115G	18120G
Purple	18110P	18115P	18120P
Yellow	18110Y	18115Y	18120Y
Orange	18110OR	18115OR	18120OR

Segura Colour Interlocking Corner
100 x 100 cm | 1 m²

Colour/Thickness	1 cm	1,5 cm	2 cm
White	18210W	18215W	18220W
Blue	18210B	18215B	18220B
Red	18210R	18215R	18220R
Green	18210G	18215G	18220G
Purple	18210P	18215P	18220P
Yellow	18210Y	18215Y	18220Y
Orange	18210OR	18215OR	18220OR



100% recycled rubber

► MORE DETAILS

Rubber Flooring Fina

100 x 100 cm | 1 m²
 Density: 1100 kg/m³
 Material: 100% recycled rubber

With our Rubber Flooring Fina system, we offer you high-quality floor mats in three different strengths for your fitness and weight areas and thus maximum safety during training, effective noise reduction and optimal protection of your floor.

With a density of 1100 kg/m³, our Fina mats are even more durable and are particularly suitable for equipping professional fitness and weight training areas. Our long-lasting system in classic black consists of 100% recyclable and environmentally friendly rubber granulate.

1100 kg/m³

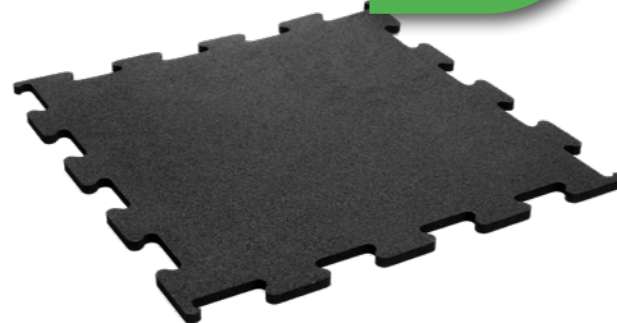

It is therefore pleasantly warm, comfortable and gives a joint-friendly running feeling.

Thanks to the tooth system, the mats can easily be laid loosely and do not slip due to their high weight and surface adhesion.

The 100 x 100 cm mats can be individually adapted to your room conditions and with their high abrasion resistance they are the perfect choice for use in fitness studios, playgrounds, kindergartens and much more.

Fina mats can be ordered with a minimum quantity of 50 pieces and delivery time of 2-3 weeks. Thickness up to 5 cm available. Please contact us for more information.

Fina	20010A	20015A	20020A
Thickness	1 cm	1,5 cm	2 cm



antislip



extremely good absorption



very good acoustic insulation



durable



sustainable production

Application area

- gyms
- cardio area
- dumbbell area
- aerobic area
- practice and therapy rooms
- playgrounds
- kindergartens

Product characteristics

- material: 100% rubber granulate
- density: 1100 kg/m³
- sustainability - 100% recycled material
- high abrasion resistance
- anti-slip property
- very good sound insulation
- easy installation and cleaning
- edge finish with elegant bevel

Fina Interlocking Border & Corner

100 x 100 cm | 1 m²

Tripping edges are avoided by the bevelled edge and corner strips and therefore offer additional safety and comfort. Create the right foundation for your fitness area now, because the premium material is tailored to the needs of your customers.

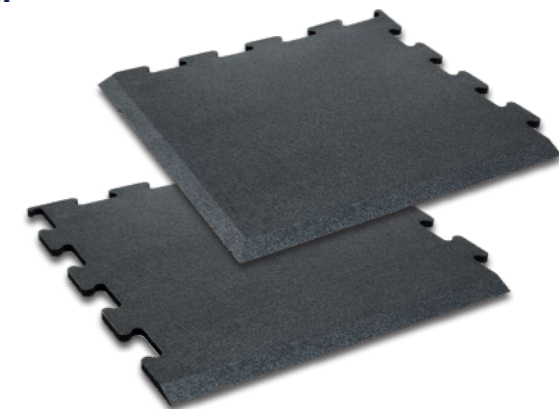

Fina Border Int.	20110A	20115A	20120A
Fina Corner Int.	20210A	20215A	20220A
Thickness	1 cm	1,5 cm	2 cm

100% recycled rubber

1100 kg/m³

▶ MORE DETAILS

Rubber Flooring Fina





100 x 100 cm | 1 m²
 Density: 1100 kg/m³
 Material: 100% recycled rubber

The Rubber Flooring Fina system with straight edges looks even simpler and blends in perfectly with the environment for different applications.

Fina mats can be ordered with a minimum quantity of 50 pieces and delivery time of 2-3 weeks. Thickness up to 5 cm available. Please contact us for more information.

Fina	19010A	19015A	19020A
Thickness	1 cm	1,5 cm	2 cm



-  antislip
-  extremely good absorption
-  very good acoustic insulation
-  durable
-  sustainable production

Fina Border & Corner

100 x 100 cm | 1 m²
 Density: 1100 kg/m³
 Material: 100% recycled rubber

We offer suitable end mats with a bevelled edge for the border and corner mats. In addition to an elegant look, this also offers an additional safety aspect.

Segura Border	19110A	19115A	19120A
Segura Corner	19210A	19215A	19220A
Thickness	1 cm	1,5 cm	2 cm

NEW

soon available

► MORE DETAILS

Rubber Flooring Segura Weight Lifting

50 x 50 cm | 0,5 m²
Density 1000 kg/m³

The particularly strong 30 mm Segura Weight Lifting rubber floor was specially designed for training areas in the heavyweight area. The floor offers a high level of safety thanks to extremely good sound and shock absorption.

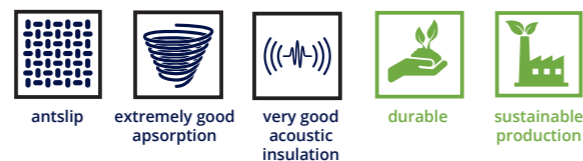

Article	21030A	21030GR
Colour	Anthracite	Grey

In anthracite or grey

The 50 x 50 cm mats can be easily laid with the help of plastic dowels and form a firm connection with the barbs of the dowels, so that the mats are absolutely non-slip.



The back of the mat has a waffle structure, which provides even better damping properties.



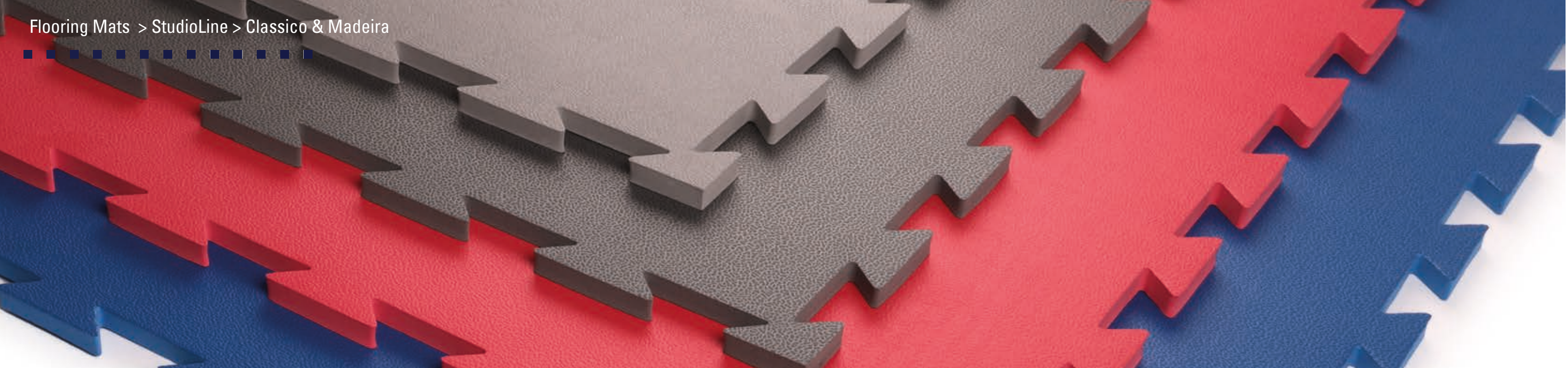

► MORE DETAILS

StudioLine Classico

100 x 100 x 1,4 cm (± 0,5 mm)

Hardness 60° – 65°

Material: EVA

The point-elastic and joint-friendly StudioLine Classico flooring is extremely resistant even under heavy use and is therefore perfectly suitable for fitness studios, therapy rooms and in the aerobic area. The floor covering reduces the development of noise and therefore creates a pleasant acoustic feeling of space.

Laying even without instructions is extremely easy and can be done directly on any substrate without costly preparation. The antibacterial floor is also easy to clean with water. StudioLine Classico offers a color selection between four different colors and thus offers interesting combination options to individually upgrade your fitness area!

Colour differences possible.

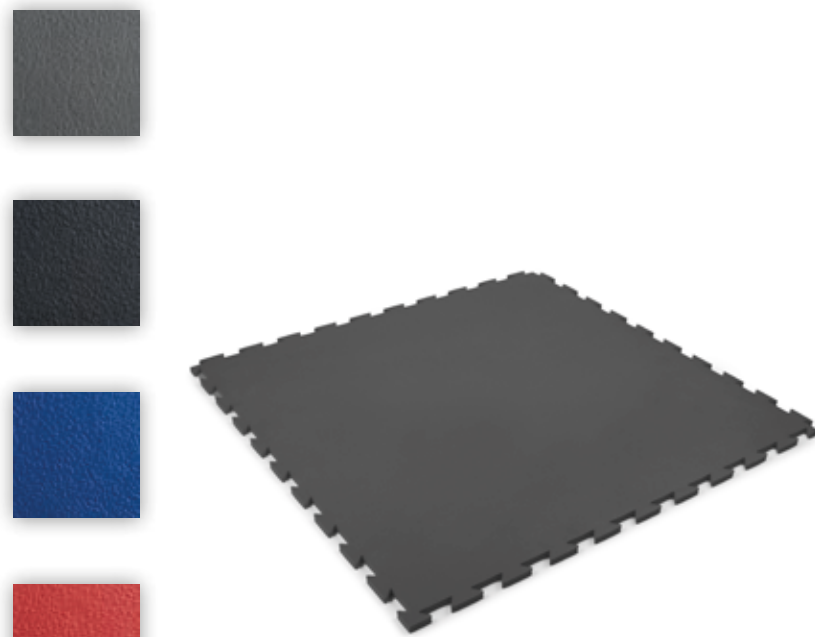

Colour	Article
Grey	8500HG
Anthracite	8500A
Blue	8500B
Red	8500R

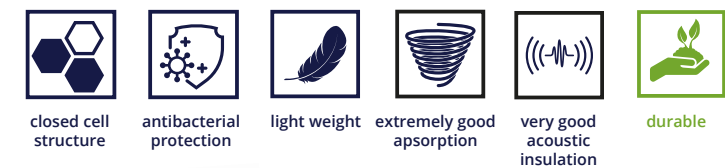

even better quality

► MORE DETAILS

StudioLine Madeira

100 x 100 x 1,4 cm (± 0,5 mm)

Hardness 60° – 65°

Material: EVA

StudioLine Madeira is the resistant floor covering for high demands in fitness studios and therapy rooms. The point-elastic and joint-friendly StudioLine Madeira floor remains dimensionally stable even under heavy use and is ideal for aerobics and therapy.

It is extremely easy to lay without instructions and can be carried out directly on any surface without costly preparation. StudioLine Madeira enhances every fitness area with its elegant wood look!

Article 8500HW

- high quality
- maximum comfort
- point elastic
- anti-germ
- noise reducing
- easy to clean without detergents



OFFICIAL COMPETITION MAT OF THE GERMAN BUDDO ASSOCIATION AND THE HKBV (WAKO MEMBER) - RECOMMENDED BY WAKO PER GERMANY

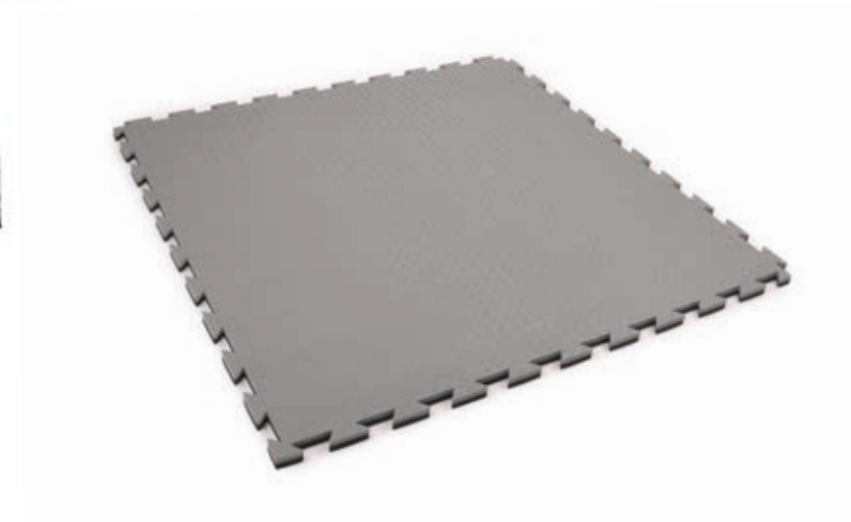

▶ MORE DETAILS

 classification according to fire behavior
DIN EN 13501 - 1 - Class E

Double Competition Standard

100 x 100 x 2cm (± 1,0 mm)
Hardness 35° – 40°
Material: EVA

Qualified for many sports, already proven in martial arts such as karate, taekwondo and kickboxing. Our Double Competition can be laid floating. Front and rear side can be used on both sides (turnaround-floormat). The interlocking-system

fixes the mats together. There is no limit for individual room design, whether in color or through integrated edge-band.

Colour differences possible.

Colour	Article
Grey/Anthracite	1123SG
Blue/Red	1123BR
Green/Yellow	1123GY

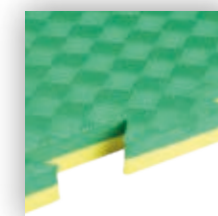
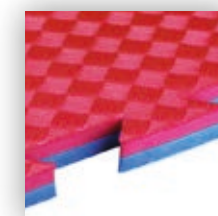
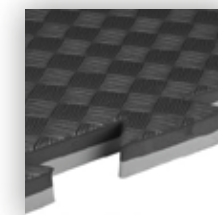

▶ MORE DETAILS

 classification according to fire behavior
DIN EN 13501 - 1 - Class E



Double CompetitionProfi

100 x 100 x 2cm (± 1,0 mm)
EN 1177 Impact Absorbing 90 cm
Hardness 50° – 55°
Material: EVA

The Double Competition Profi is even more resistant and better shock-absorbing properties. The mat meets the highest standards and is recommended by martial arts associations and used for competitions.

Colour differences possible.

Colour	Article
Grey/Anthracite	3123SG
Blue/Red	3123BR
Green/Yellow	3123GY

- 
closed cell structure
- 
antibacterial protection
- 
light weight
- 
extremely good absorption
- 
very good acoustic insulation
- 
durable

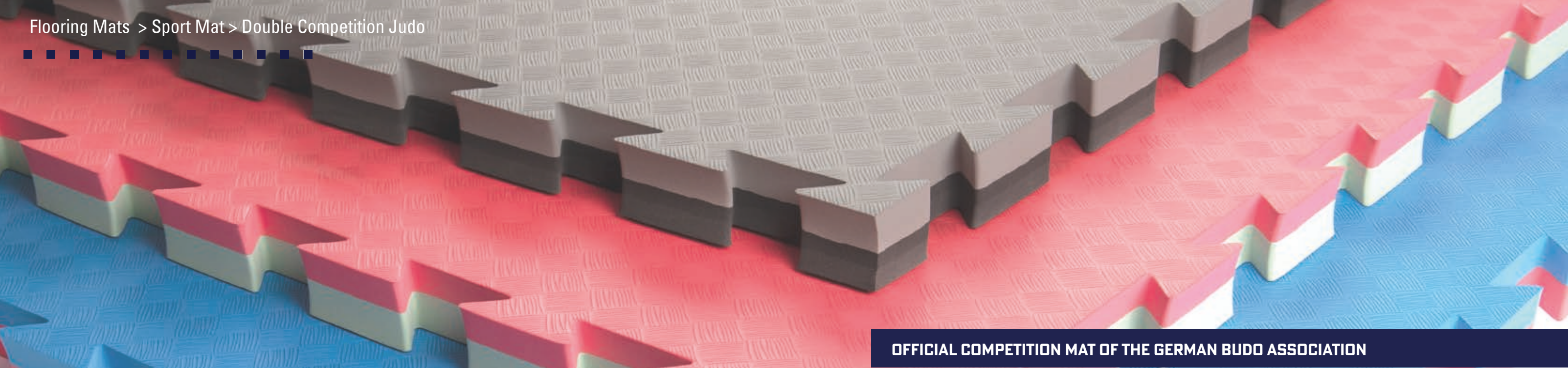

OFFICIAL COMPETITION MAT OF THE GERMAN BUDO ASSOCIATION

 classification according to fire behavior
DIN EN 13501 - 1 - Class E

[▶ MORE DETAILS](#)

Double Competition Judo

100 x 100 x 4 cm (± 1,5 mm)
EN 1177 Impact absorbing 160 cm
Hardness 30° – 35°
Material: EVA

Qualified for many sports, already proven in material arts such as karate, taekwondo and kickboxing. Our Double Competition can be laid loosely. Front and rear side can be used on both sides (turnaround-floor mat). The interlocking-system fixes the mats together. There is no limit for individual room design, whether in colour or through integrated edge-band.





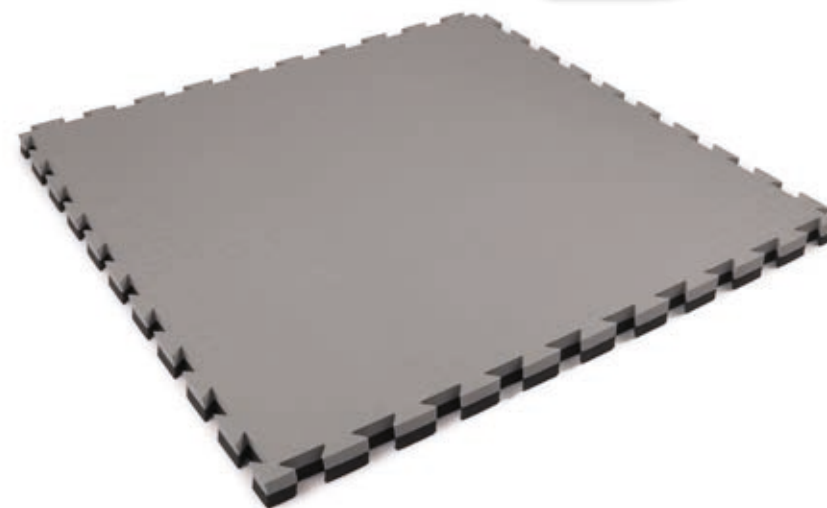

Colour differences possible.

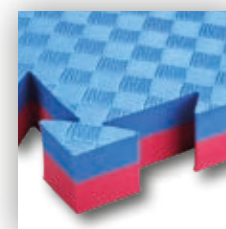
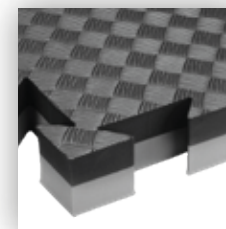
Colour	Article
Grey/Anthracite	4123SG
Blue/Red	4123BR
Green/Red	4123GR



4 cm thick!



- 
closed cell structure
- 
antibacterial protection
- 
light weight
- 
extremely good absorption
- 
very good acoustic insulation
- 
durable



Did you know?
The Double Judo Competition is the **official competition mat** of the German Budo Association and stands for professionalism and quality.

▶ BRANDING CATALOGUE

